



INSTALLATION GUIDE

Hybrid (Type A+B) LED T8 Color Selectable Tube

Note: This product complies with Part 18 of the FCC rules but may cause interference to radios, televisions, wireless telephones, and remote controls. If interference occurs, move the product away from these devices or plug it into a different outlet. Do not install this product near maritime safety communications equipment or other critical navigation or communication equipment operating between 0.45-30MHz.

NOTE: This equipment has been tested and found to comply with the limits for a Class B digital device, pursuant to Part 15 of the FCC Rules. These limits are designed to provide reasonable protection against harmful interference in a residential installation. This equipment generates, uses, and can radiate radio frequency energy and, if not installed and used in accordance with the instructions, may cause harmful interference to radio communications. However, there is no guarantee that interference will not occur in a particular installation. If this equipment does cause harmful interference to radio or television reception, which can be determined by turning the equipment off and on, the user is encouraged to try to correct the interference by one or more of the following measures:

- Reorient or relocate the receiving antenna.
- Increase the separation between the equipment and receiver.
- Connect the equipment into an outlet on a circuit different from that to which the receiver is connected.
- Consult the dealer or an experienced radio/TV technician for help.

This Class B digital apparatus complies with Canadian ICES-005.

The units covered by this report were intended to retrofit surface mount with diffuser for these models, Type IC or non-IC recessed mount listed fluorescent luminaires that use maximum four tubular lamps, the minimum lamp compartment dimensions are tabulated below:

Model	MINIMUM LAMP COMPARTMENT DIMENSIONS [Length x Width x Height][IN]
48T8-12-8CS-HYB-D-LED	47.9 x 22.6 x 2.6
36T8-12-8CS-HYB-D-LED	36.2 x 22.4 x 2.6
24T8-8-8CS-HYB-D-LED	24.5 x 22.2 x 2.6

PARTS/COMPONENTS INCLUDED IN KIT

- Installation Instructions
- LED Tube Lamp
- Luminaire Marking Labels. Only for Type B installation please apply the following lamp replacement label on the retrofit luminaire after the retrofit kit has been installed, where readily visible by the user during

relamping, and after installation.



WARNINGS

TYPE A Application (PLUG & PLAY, Ballast compatible)

To avoid personal injury and/or possible product damage, the following cautions must be followed:

- Read all safety information and instructions before installation.
- RISK OF ELECTRIC SHOCK. Disconnect power at fuse or circuit breaker before installing or servicing.
- Suitable for damp locations - Not for use where directly exposed to water.
- Caution: Do not use with dimmers.
- This device is not intended for use with emergency exits.
- CAUTION - RISK OF FIRE. USE ONLY IN PLACE OF FLUORESCENT LAMPS SPECIFIED ON PRODUCT LABEL.
- CAUTION RISK OF FIRE – IF THE LAMP OR LUMINAIRE EXHIBITS UNDESIRABLE OPERATION (BUZZING, FLICKERING, ETC), IMMEDIATELY TURN OFF POWER, REMOVE LAMP FROM LUMINAIRE AND CONTACT MANUFACTURER.
- CAUTION - RISK OF FIRE. IF LAMP DOES NOT LIGHT WHEN THE LUMINAIRE IS ENERGIZED, REMOVE LAMP FROM LUMINAIRE AND CONTACT LAMP MANUFACTURER OR QUALIFIED ELECTRICIAN.
- CAUTION - RISK OF FIRE OR ELECTRIC SHOCK. When working with electronics ballast, please check the compatible list first. If you do not find your ballast on the list, then please bypass the fixture as a Type B installation or contact us for support. Do not install the LED tube with the ballast which not on the ballast compatible list.
- To prevent damage to lamp, lamp must not be energized when color (CCT) selector switch is changed.



WARNINGS

TYPE B Application (DIRECT WIRE, Ballast-Free)

To avoid personal injury and/or possible product damage, the following cautions must be followed:

- Read all safety information and instructions before installation.
- RISK OF ELECTRIC SHOCK. Disconnect power at fuse or circuit breaker before installing or servicing.
- To prevent damage to lamp, lamp must not be energized when color (CCT) selector switch is changed.
- Suitable for damp locations - Not for use where directly exposed to water.
- Caution: Do not use with dimmers.
- This device is not intended for use with emergency exits.
- To prevent early lamp failure, lamp should only be installed in operating environments ranging between: -20°C and +45°C (-4°F and +113°F).
- WARNING – RISK OF FIRE OR ELECTRIC SHOCK. LED Retrofit Kit installation requires knowledge of luminaires electrical systems. If not qualified, do not attempt installation. Contact a qualified electrician.
- WARNING – RISK OF FIRE OR ELECTRIC SHOCK. Install this kit only in the luminaires that have the construction features and dimensions shown in the photographs and/or drawings and where the input rating of the retrofit kit does not exceed the input rating of the luminaire.
- Do not make or alter any open holes in an enclosure of wiring or electrical components during kit installation.

- **WARNING** - To prevent wiring damage or abrasion, do not expose wiring to edges of sheet metal or other sharp objects.
- Installers should not disconnect existing wires from lamp socket terminals to make new connections at lamp socket terminals. Instead, installer should cut existing lamp socket leads away from the lamp socket and make new electrical connections to lamp socket lead wires by employing connectors suitable for the application.
- THIS RETROFIT KIT IS ACCEPTED AS A COMPONENT OF A LUMINAIRE WHERE THE SUITABILITY OF THE COMBINATION SHALL BE DETERMINED BY AUTHORITIES HAVING JURISDICTION. PRODUCT MUST BE INSTALLED BY A QUALIFIED ELECTRICIAN IN ACCORDANCE WITH THE APPLICABLE AND APPROPRIATE ELECTRICAL CODES. THE INSTALLATION GUIDE DOES NOT SUPERSEDE LOCAL OR NATIONAL REGULATIONS FOR ELECTRICAL INSTALLATIONS.
- Examine all parts that are not intended to be replaced by the retrofit kit for damage and replace any damaged parts prior to installation of the retrofit kit.
- The tube is installed as Type B, the luminaire, once modified as retrofit fixture, will no longer operate fluorescent lamps.
- For a linear tubular LED lamp conversion, there shall be text or a diagram showing how the supply connections were made to the lamp holders so the correct dimming connections will be made to the lamp when the lamp is installed or replaced.

TYPE A - Wiring diagram:

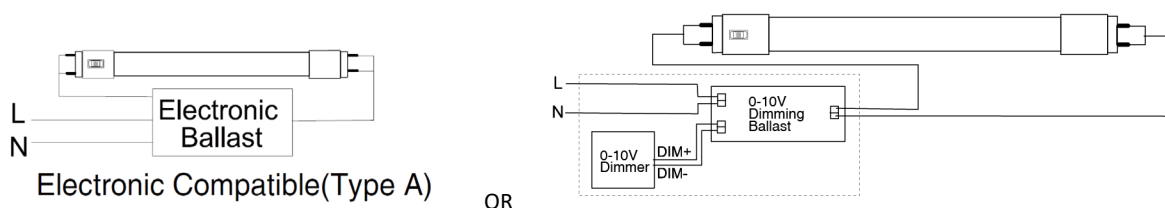

Note:

The wiring diagram should be the same with the ballast wiring diagram.

When work with ballast, please check the compatible list first! If you do not find your ballast on the list then please bypass the fixture, or please contact us! Do not install the LED tube with the ballast which not on the ballast compatible list.

TYPE A (Plug and Play) Installation Guide:

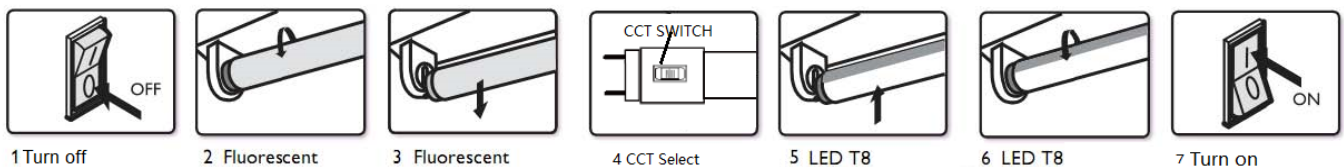

Instructions

1. Switch-off power to the luminaire.
2. Remove diffuser (if one is present).
3. Remove the existing fluorescent lamps from the luminaire.
4. Select the color temperature through the CCT switch on the LED lamp base.
 - Using the color (CCT) selector switch on the base, select the desired color temperature (3500K, 4000K, or 5000K).
 - To prevent damage to lamp, lamp must not be energized when color (CCT) selector switch is changed.

5. Install the LED tube lamp.
6. Install diffuser (if removed in step 2)
7. Switch on power to the luminaire.
8. Before installation, please check specifications for the most current ballast compatibility list, if no compatibility is found, please insert led tubes according to below Type B installation instructions.

WARNING - Risk of fire: Tubes must be installed with the end cap marks in correct alignment with the sockets as show below. Please ensure the mark is aligned with socket as shown below:

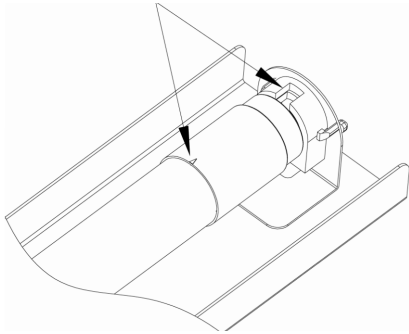

TYPE B - Wiring diagram:

Connect two wires to branch circuit L and N according to the below figure.

Case 1: Direct AC wiring diagram without dimming

1. Single-ended power input

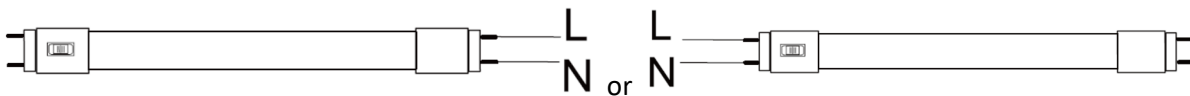

Input voltage:120-277V 50/60Hz

2. Double-ended power input

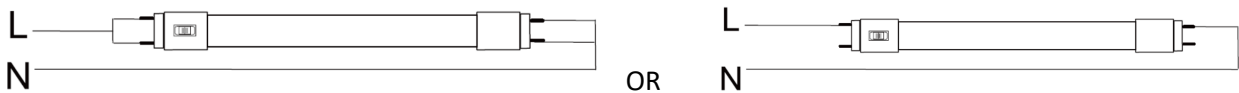

Input voltage:120-277V 50/60Hz

Case 2: Direct AC wiring diagram with 0-10V dimming system

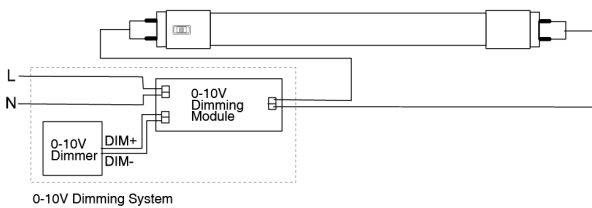

Voltage Input: AC120-277V 50/60Hz

Important Notes:

- For single-ended wiring installation of tubes, un-shunted lamp holders must be used.
- For double-ended wiring installation, it is not needed to change the sockets/lamp holders (if they are in good condition) regardless of the type of sockets.

TYPE B (Ballast Bypass) Installation Guide:

Please completely comply with these instructions and notes to ensure that the product is operated in a safe condition. Important safety information - read all instructions before installation.

Instructions

1. DISCONNECT POWER OF LUMINAIRE

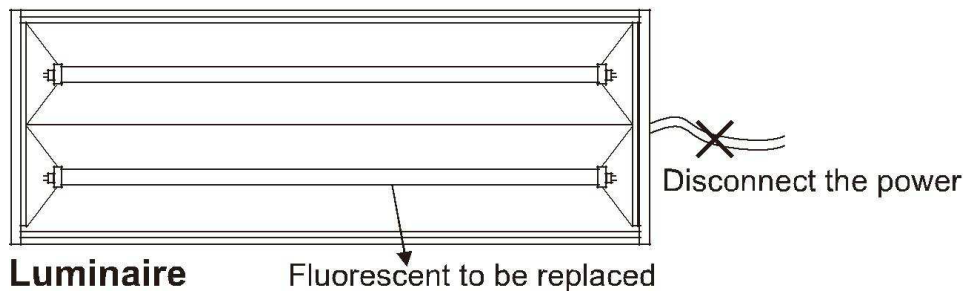

Disconnect power to luminaire or circuit (if possible). Ensure all power is off by using a voltmeter or other method to confirm.

2. REMOVE EXISTING TUBE LAMP(S)

- a. Remove troffer lens if present.
- b. Remove existing fluorescent by rotating one quarter turn and sliding lamp(s)
- c. Remove ballast cover. (Cover may be secured with screws or tabs)



a) Troffer and lamps b) Remove tube lamps c) Remove ballast cover (lens removed)

3. RETROFIT LUMINAIRE

Modify the circuit according to the TYPE B wiring diagram.

4. SELECT THE CCT

Select the color temperature through the CCT switch on the LED lamp's base

- Using the color (CCT) selector switch on the base, select the desired color temperature (3500K, 4000K, or 5000K).
- To prevent damage to lamp, lamp must not be energized when color (CCT) selector switch is changed.

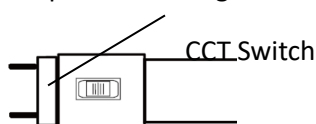

5. INSERT LED TUBES

- a. Read label on the LED tube to ensure the power end of LED is aligned with powered tube socket, then insert LED lamp in the normal way by sliding pins into sockets and rotating a quarter turn until LED tube

locks in place.

b. LED lamps are now fully installed.

c. Replace troffer lens if present.

d. After modification completed. Attach the Replacement Marking and cautionary Label to a visible place on the luminaire and keep it visible after installation. Be sure to mark the type of wiring on the luminaire label (single or double-ended).

6. RESTORE THE POWER OF LUMINAIRE

Restore power to circuit/luminaire and test light. If necessary, adjust position of LED tube, and enjoy your new LED tube light!