



LED LUMINAIRES

Halco Adjustable Full-Cutoff Wallpack



DLC Premium



Title 24



UL Rated



5 Year Warranty



RoHS Compliant

The Adjustable Full-Cutoff offers versatility and optimal light output where it's needed. The Wallpack has a forward throw distribution and can be adjusted up to 90 degrees. With multiple lumen packages to choose from, it can meet almost any outdoor application need. The LED technology and die-cast aluminum housing enable long term reliability and minimal maintenance over the course of its lifetime.



Halco
LIGHTING TECHNOLOGIES

Adjustable head pivots up to 90°

Multiple Lumen Packages

High Ambient Operating Temperature

Designed to Significantly Reduce Light Pollution

Innovative Die-Casting & Heat Sink

Applications:

- Warehouses
- Schools
- Apartment Complexes
- Personnel Doors
- Loading Docks
- Driveways

Contact Your Customer Care Specialist For Pricing, Orders And Technical Support.

800.677.3334 www.halcolighting.com

Halco Adjustable Full-Cutoff Wallpack

Product #: _____ Type: _____

Project: _____ Date: _____

Comments: _____ Initials: _____

Performance

- 4 wattages, multiple lumen packages
- LEDs are rated for greater than 100,000 hour life with calculated lumen maintenance >70% (L70) at 25°C.
- 0-10V dimmable driver standard available in 120-277V
- -40° to +50°C Ambient Operating Temperature
- Power Factor > 0.9
- 4kV Surge Protection

Construction

- IK 09 Die Cast Aluminum Housing with Integral Heat Sink for Heat Dissipation
- High Efficiency, recessed optics for increased visual comfort

Environment

- IP65 Rated
- UL Wet Location Listed
- RoHs Compliant
- Meets FCC Part 15, Subpart B, Class A standards for conducted and radiated emissions

Certification

- All luminaires are built to UL1598 standards, and bear appropriate cULus labels for wet location
- Dark Sky with 3000K options
- DLC Premium Listed

Design

- Sleek, architectural design
- Adjustable head pivots up to 90°
- Designed for easy installation

Ordering Information

Watt	Product #	Product Code	Volts	Color Temp	CRI	Lumen Output	Useful Life	Dimmable	Equivalent Wattage
12	10275	WP-FCA12U30	120-277V	3000K	70	1440	100,000	No	50W MH
12	10334	WP-FCA12U40	120-277V	4000K	70	1452	100,000	No	50W MH
12	10279	WP-FCA12U50	120-277V	5000K	70	1491	100,000	No	50W MH
24	10276	WP-FCA24U30	120-277V	3000K	70	2770	100,000	No	100W MH
24	10335	WP-FCA24U40	120-277V	4000K	70	2770	100,000	No	100W MH
24	10280	WP-FCA24U50	120-277V	5000K	70	3038	100,000	No	100W MH
50	10277	WP-FCA50U30	120-277V	3000K	70	5588	100,000	0-10V	150W MH
50	10336	WP-FCA50U40	120-277V	4000K	70	6131	100,000	0-10V	150W MH
50	10281	WP-FCA50U50	120-277V	5000K	70	6221	100,000	0-10V	150W MH
75	10278	WP-FCA75U30	120-277V	3000K	70	8045	100,000	0-10V	250W MH
75	10337	WP-FCA75U40	120-277V	4000K	70	8683	100,000	0-10V	250W MH
75	10282	WP-FCA75U50	120-277V	5000K	70	9594	100,000	0-10V	250W MH

Product Specification Table

Rated Wattage	12	24	50	75
Equivalent Wattage	50W	100W	150W	250W
Power Factor	>0.9			
L70 Lifetime*	>100,000 hrs			
Input Voltage	120-277VAC			
Total Harmonic Distortion (THD)	<15			
Surge Protection	4kV surge suppression protection tested in accordance with IEEE/ANSI C62.41.2			
Optical Distribution	110			
Mounting Options	Surface Mount			
CCT	3000K, 4000K, 5000K			
Warranty	Halco Standard 5 Year, 10 Year Available			
Finish	Bronze			
Wet	IP65 and UL Wet Listing			
DLC	DLC Premium			

Halco Adjustable Full-Cutoff Wallpack

Product #: _____ Type: _____

Project: _____ Date: _____

Comments: _____ Initials: _____

Dimensions

12W & 24W Dimensions

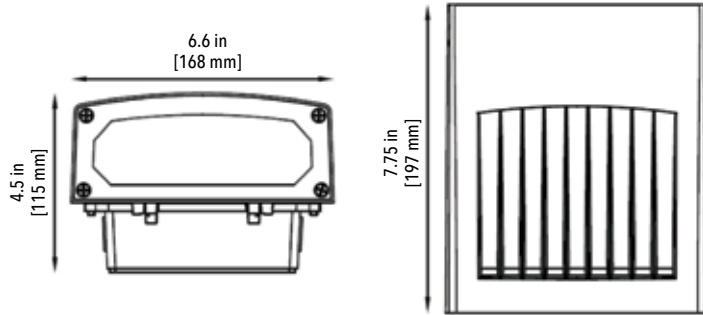

50W & 75W Dimensions

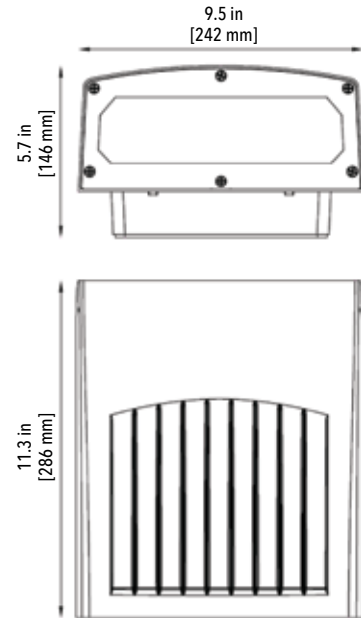

Photometrics

Photometric Report

Please Download the Reports for complete photometric data

LEGEND

- 0.25 fc
- 0.5 fc
- 1 fc
- 2 fc
- 5 fc

12 WATT

Polar Candida Distribution

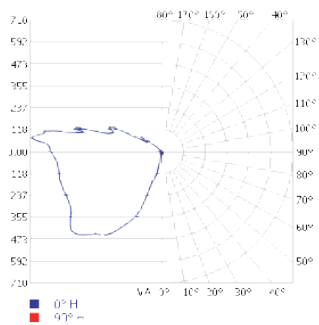

Isofootcandle Plot

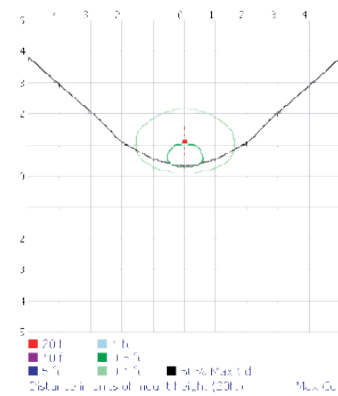

ZONAL LUMEN SUMMARY

ZONE	LUMENS	% LAMP	% LUMINAIRE
0-30	66.8	4.5%	4.5%
0-40	171.4	11.5%	11.5%
0-60	513.7	34.4%	34.4%
60-90	584.7	39.2%	39.2%
70-100	573.8	38.5%	38.5%
90-120	358.5	24%	24%
0-90	1,098.5	73.7%	73.6%
90-180	393.1	26.4%	26.4%
0-180	1,491.6	100%	100%

LUMENS PER ZONE

ZONE	LUMENS	% TOTAL	ZONE	LUMENS	% TOTAL
0-10	0.8	0.1%	90-100	187.4	12.6%
10-20	12.6	0.8%	100-110	113.7	7.6%
20-30	53.5	3.6%	110-120	57.4	3.8%
30-40	104.5	7.0%	120-130	22.7	1.5%
40-50	154.5	10.4%	130-140	5.5	0.4%
50-60	187.8	12.6%	140-150	2.9	0.2%
60-70	198.4	13.3%	150-160	2.1	0.1%
70-80	196.9	13.2%	160-170	1.1	0.1%
80-90	189.5	12.7%	170-180	0.3	0%

24 WATT

Polar Candida Distribution

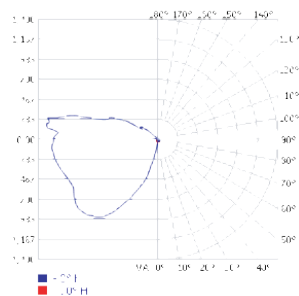

Isofootcandle Plot

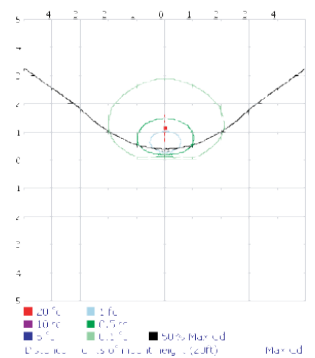

ZONAL LUMEN SUMMARY

ZONE	LUMENS	% LAMP	% LUMINAIRE
0-30	124.7	4.1%	4.1%
0-40	324.5	10.7%	10.7%
0-60	994.0	32.7%	32.7%
60-90	1,209.3	39.8%	39.8%
70-100	1,183.5	38.9%	38.9%
90-120	758.8	25%	25%
0-90	2,203.3	72.5%	72.5%
90-180	836.0	27.5%	27.5%
0-180	3,039.3	100%	100%

LUMENS PER ZONE

ZONE	LUMENS	% TOTAL	ZONE	LUMENS	% TOTAL
0-10	1.7	0.1%	90-100	368.4	12.1%
10-20	26.1	0.9%	100-110	266.6	8.8%
20-30	96.9	3.2%	110-120	123.8	4.1%
30-40	199.8	6.6%	120-130	53.0	1.7%
40-50	300.7	9.9%	130-140	11.5	0.4%
50-60	368.8	12.1%	140-150	5.8	0.2%
60-70	394.1	13.0%	150-160	4.1	0.1%
70-80	408.5	13.4%	160-170	2.1	0.1%
80-90	406.6	13.4%	170-180	0.7	0%

Halco Adjustable Full-Cutoff Wallpack

Product #: _____ Type: _____

Project: _____ Date: _____

Comments: _____ Initials: _____

Photometrics

Photometric Report

Please Download ies Reports for complete photometric data

LEGEND

- 0.25 fc
- 0.5 fc
- 1 fc
- 2 fc
- 5 fc

50 WATT

Polar Candida Distribution

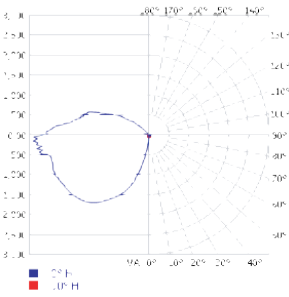

Isofootcandle Plot

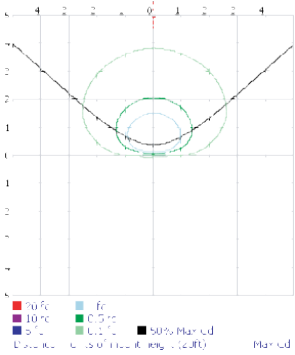

ZONAL LUMEN SUMMARY			
ZONE	LUMENS	% LAMP	% LUMINAIRE
0-30	322.3	5.2%	5.2%
0-40	727.1	11.7%	11.7%
0-60	2,010.5	32.3%	32.3%
60-90	2,486.4	40%	40%
70-100	2,384.6	38.3%	38.3%
90-120	1,511.4	24.3%	24.3%
0-90	4,496.9	72.3%	72.3%
90-180	1,725.5	27.7%	27.7%
0-180	6,222.4	100%	100%

LUMENS PER ZONE					
ZONE	LUMENS	% TOTAL	ZONE	LUMENS	% TOTAL
0-10	8.9	0.1%	90-100	695.4	11.2%
10-20	81.2	1.3%	100-110	503.3	8.1%
20-30	232.2	3.7%	110-120	312.7	5%
30-40	404.8	6.5%	120-130	146.1	2.3%
40-50	574.6	9.2%	130-140	41.5	0.7%
50-60	708.8	11.4%	140-150	13.1	0.2%
60-70	797.2	12.8%	150-160	7.6	0.1%
70-80	823.9	13.2%	160-170	4.3	0.1%
80-90	865.3	13.9%	170-180	1.4	0%

75 WATT

Polar Candida Distribution

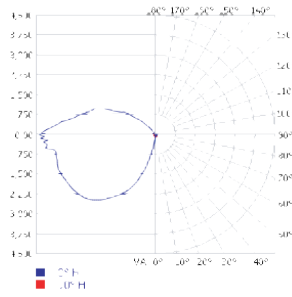

Isofootcandle Plot

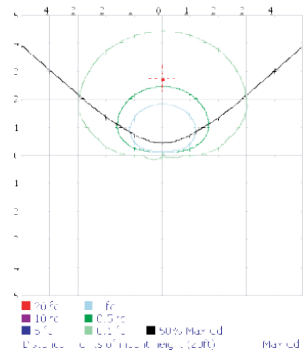

ZONAL LUMEN SUMMARY			
ZONE	LUMENS	% LAMP	% LUMINAIRE
0-30	384.5	4%	4%
0-40	941.5	9.8%	9.8%
0-60	2,824.9	29.4%	29.4%
60-90	3,780.7	39.4%	39.4%
70-100	3,727.9	38.9%	38.9%
90-120	2,561.9	26.7%	26.7%
0-90	6,605.6	68.8%	68.8%
90-180	2,989.8	31.2%	31.2%
0-180	9,595.4	100%	100%

LUMENS PER ZONE					
ZONE	LUMENS	% TOTAL	ZONE	LUMENS	% TOTAL
0-10	6.9	0.1%	90-100	1,154.6	12%
10-20	84.2	0.9%	100-110	842.1	8.8%
20-30	293.4	3.1%	110-120	565.2	5.9%
30-40	557.0	5.8%	120-130	286.2	3%
40-50	828.6	8.6%	130-140	97.6	1%
50-60	1,054.8	11.0%	140-150	23.7	0.2%
60-70	1,207.4	12.6%	150-160	11.9	0.1%
70-80	1,267.8	13.2%	160-170	6.5	0.1%
80-90	1,305.4	13.6%	170-180	2.0	0%