

# ProLED Select® 4" Gimbal Downlight Series Installation Guide



## IMPORTANT

**READ CAREFULLY BEFORE INSTALLING FIXTURE. RETAIN THESE INSTRUCTIONS FOR FUTURE REFERENCE.**

### WARNINGS:

- Risk of electrical shock. Disconnect power at fuse or circuit breaker before installing or servicing.
- To prevent early lamp failure, lamp should only be installed in operating environments ranging between  $-15^{\circ}\text{C}$  and  $+40^{\circ}\text{C}$  ( $-4^{\circ}\text{F}$  and  $+104^{\circ}\text{F}$ ).
- No user serviceable parts inside. To avoid electrical shock do not disassemble product.
- Risk of fire or electric shock, LED Retrofit Kit installation requires knowledge of luminaires electrical systems. If not qualified, do not attempt installation. Contact a qualified electrician.
- Risk of fire or electric shock, Install this kit only in luminaires that have the construction features and min dimensions shown in the Figure 1 and where the input rating of the retrofit kit does not exceed the input rating of the luminaire.
- Do not make or alter any open holes in an enclosure of wiring or electrical components during kit installation
- To prevent wiring damage or abrasion, do not expose wiring to edges of sheet metal or other sharp objects.
- Installers should not disconnect existing wires from lampholder terminals to make new connections at lampholder terminals, Instead installers should cut existing lampholder leads away from the lampholder and make new electrical connections to lampholder lead wires by employing applicable connectors.
- This retrofit kit is accepted as a component of a luminaire where the suitability of the combination shall be determined by authorities having jurisdiction.
- This device is not intended for use with emergency exits.
- This retrofit kits suitable for wet locations luminaires specified as below : Type Non IC; Type IC; Covered ceiling ; Uncovered ceiling.

## MIN. LUMINAIRE DIMENSION

Fig: 1

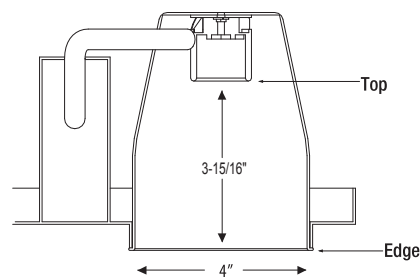

# ProLED Select® 4" Gimbal Downlight Series Installation Guide



## INSTALLATION INSTRUCTIONS

1. Make sure the power is turned off at the source to the recessed housing(s) that you are installing the fixture(s) in. Remove existing trim and CFL, or Incandescent bulbs.
2. Screw E26 base adaptor into socket in recessed housing. (Fig. 2)

Fig: 2

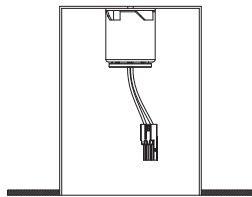

3. Select desired CCT. (Fig. 3)

Fig: 3

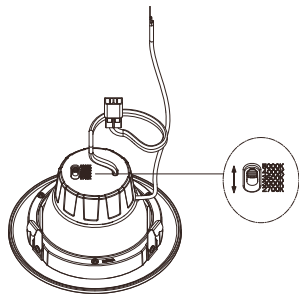

4. Plug E26 base cable connector into the LED Recessed Kit. Make sure the kit is grounded. (Fig. 4)

Fig: 4

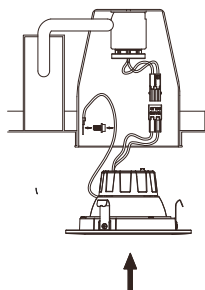

5. Carefully route wires into fixture. Utilizing the friction clips, guide fixture into the housing for a tight fit. (Fig. 5)

Fig: 5

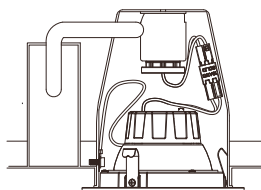

## INSTALLATION INSTRUCTIONS(Cont'd)

6. Push Recessed Kit up flush to ceiling surface. (Fig. 6)

Fig: 6

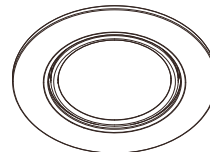

7. Push the edge of the bezel to tilt lens. Rotate lens assembly horizontally towards the surface to be illuminated. (Fig. 7)

Fig: 7

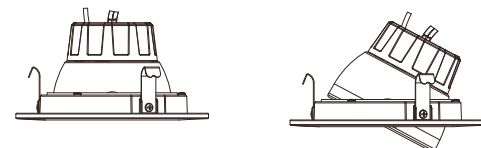

## DIMENSIONAL DRAWINGS

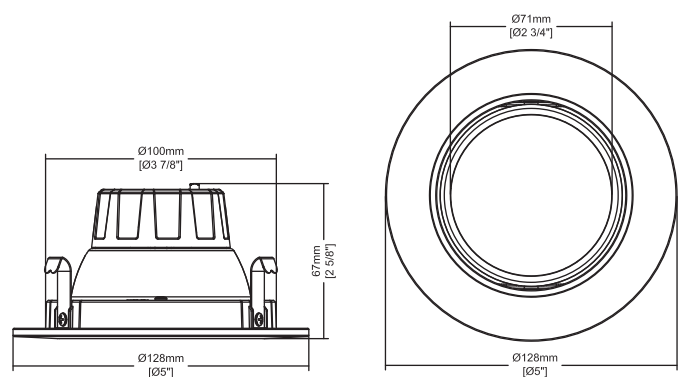

### Warranty Information:

This product is warranted for five years from the date of purchase. If this product does not perform to the specifications supplied on this package, send an email or write to the address below for product return and replacement. This replacement is the sole remedy available. Liability for incidental or consequential damage is expressly excluded. Visit [www.halcolighting.com](http://www.halcolighting.com) for full warranty details and compatibility information.