

4FT High Efficiency/High Output Type B T8 LED Installation Guide



For Skus 87200, 87201, 87202, 87203, 87204, 87205

READ ALL WARNINGS AND INSTRUCTIONS PRIOR TO INSTALLING THE T8 RETROFIT LAMPS TO ENSURE SAFETY AND PROPER OPERATION

WARNINGS

Risk of fire or electric shock. LED Retrofit Kit installation requires knowledge of luminaires electrical systems. If not qualified, do not attempt installation. Contact a qualified electrician in accordance with the National Electrical Code and relevant local code. Install this kit only in the luminaires that have the construction features and dimensions shown in the photographs and/or drawings.

WARNING - To prevent wiring damage or abrasion, do not expose wiring to edges of sheet metal or other sharp objects. Do not make or alter any open holes in an enclosure of wiring or electrical components during kit installation.

WARNING - Risk of electric shock - Do not use where direct exposed to water. Direct replacement for the following lamps only: 32W/ 48T8.

WARNING - Risk of fire - If the LED tube exhibits undesirable operation (Buzzing, flickering, etc.), immediately turn off power, remove LED tube from luminaire and contact manufacturer.

WARNING - Risk of fire - Do not install this LED tube in a pre-heat luminaire. This LED tube works on 120V to 277V AC. If lamp does not light when the luminaire is energized, remove LED tube from luminaire and contact LED tube manufacturer or qualified electrician.

SUITABLE FOR DAMP LOCATIONS.

BALLAST BYPASS DOUBLE-ENDED

4FT High Efficiency/High Output Type B T8 LED Installation Guide



This device is not intended for use with emergency exits. Suitable for use with both shunted and non-shunted lamp holders.

INSTALLATION GUIDE

1. Read all WARNINGS before continuing this section.
2. This item is rated at 120-277V. Installer must determine whether line voltage 120-277V is available at the luminaire before installation.
3. Make sure POWER IS TURNED OFF AT THE SOURCE. Do not simply switch off fixture.
4. Remove existing covers from the light fixtures according to the light fixture manufacturer's instructions. Carefully remove the existing fluorescent tubes and dispose of them according to federal, state and local laws.
5. Cut off wires connected to ballast, and remove ballast (and starter if present). Dispose of removed ballast according to federal, state and local laws.
6. If applicable, replace lamp holders at power end with both shunted and non-shunted lamp holders.
7. Connect (AC-L) from power source into lamp holder "L In".
8. Connect Neutral (N) from power source into lamp holder "N In".
9. If installing a single tube refer to follow chart. If connecting multiple lamps, continue reading.
10. Connect separate hot wire into "Hot out" from primary source lamp holder and connect that wire into "Hot in" on the adjacent tube.
11. Connect separate neutral wire into "Neutral out" from primary source lamp holder and connect that wire into "Neutral in" on the adjacent tube. See Diagram below.
12. Continue this process for additional lamps.
13. This device is powered on Double-ended, the end with L and N markings. See following chart. Do not wire opposite end of lamp holder.
14. Install lamp with the L and N markings into the wired lamp holder end.
15. Visibly affix "Modification Sticker" to the fixture and reinstall housing cover and lens if applicable.
16. Return power back to source and installation is now completed.

4FT High Efficiency/High Output Type B T8 LED Installation Guide



⚠ The ballast wiring represents typical configuration.

The actual ballast wiring varies according to ballast model. It is not needed to change socket (if in good condition) to operate double ended lamps, regardless the type of sockets. Please make sure one side of fixture is connected to Live (L) and the other side to Neutral (N).

Wiring Instruction

Retrofit luminaire with 1 lamp

Instant Start

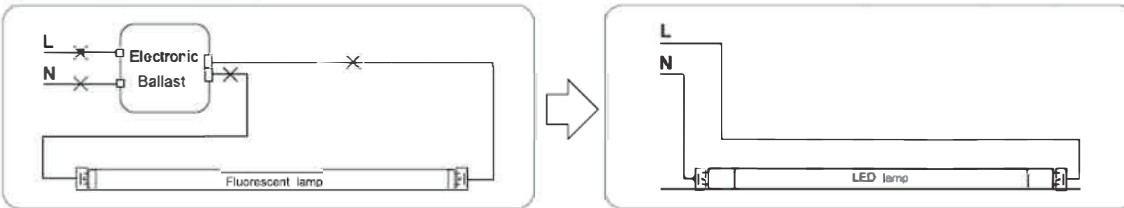

Program Start or Rapid Start

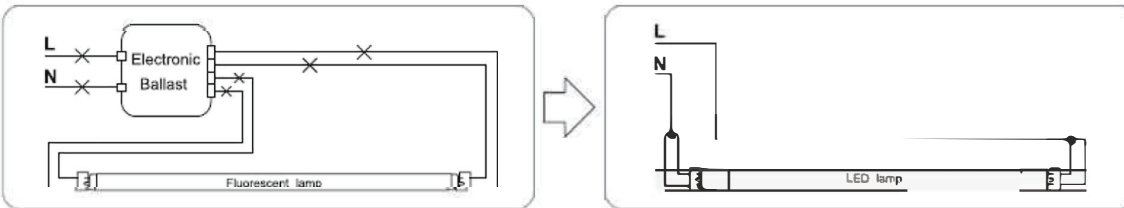

Retrofit luminaire with 2 lamps

Instant start

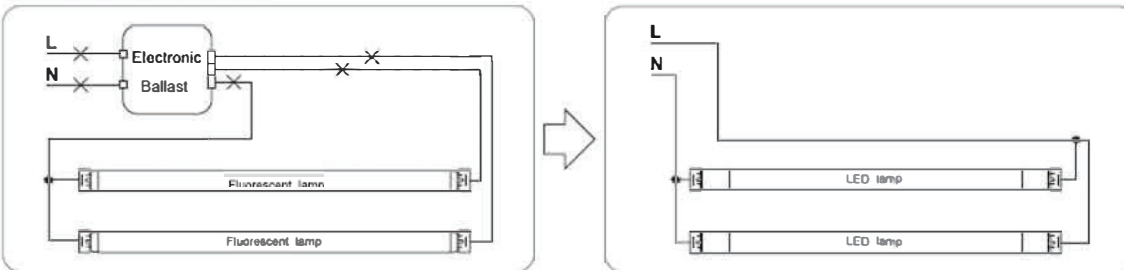

Program Start or Rapid Start

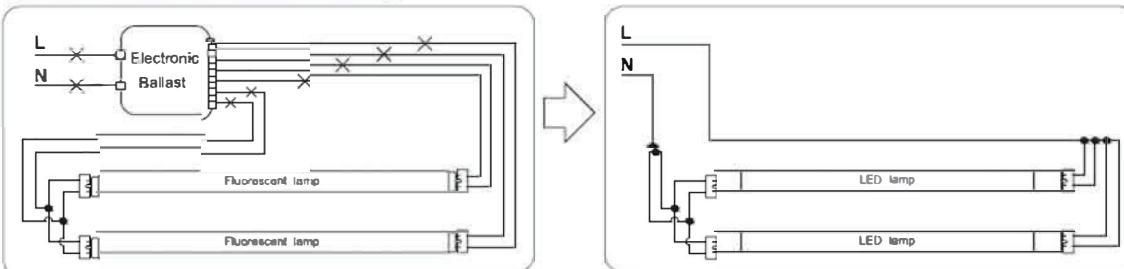

4FT High Efficiency/High Output Type B T8 LED Installation Guide



Wiring Instruction

Retrofit luminaire with 3 lamps

Instant start

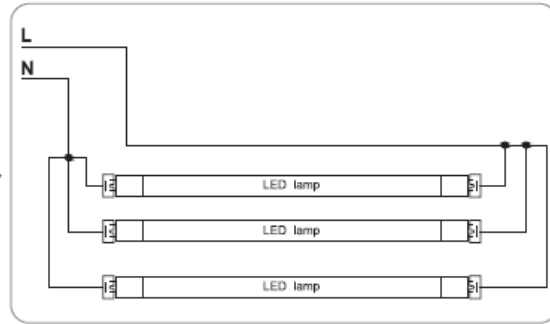
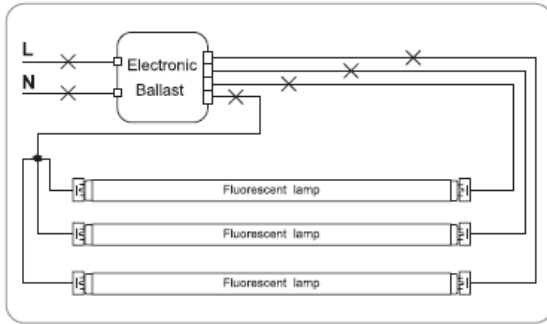

Program Start or Rapid Start

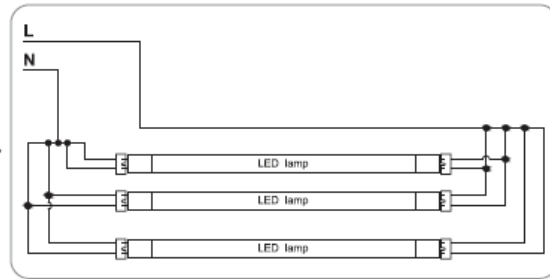
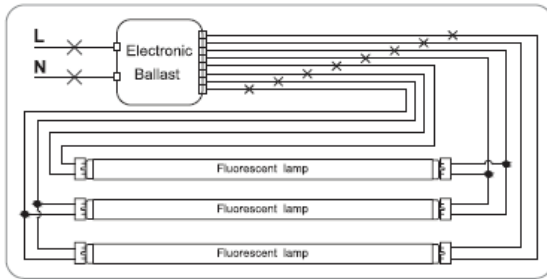

Retrofit luminaire with 4 lamps

Instant start

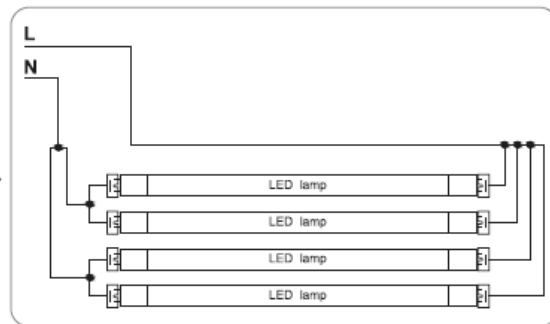
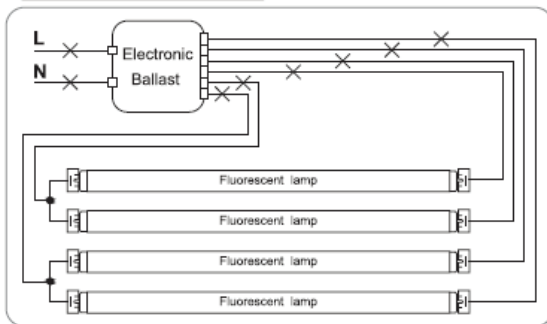

Program Start or Rapid Start

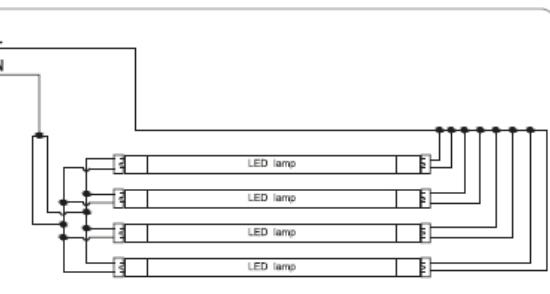
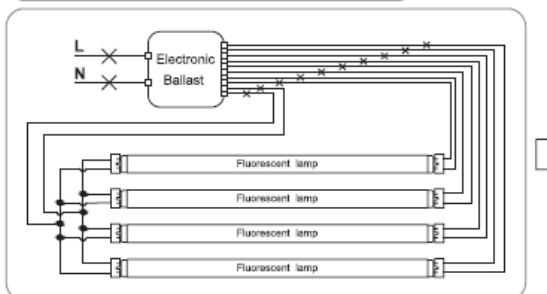

4FT High Efficiency/High Output Type B T8 LED Installation Guide



BALLAST BYPASS SINGLE-ENDED POWER

READ ALL WARNINGS AND INSTRUCTIONS PRIOR TO INSTALLING THE T8 RETROFIT LAMPS TO ENSURE SAFETY AND PROPER OPERATION

WARNINGS

Risk of fire or electric shock. LED Retrofit Kit installation requires knowledge of luminaires electrical systems. If not qualified, do not attempt installation. Contact a qualified electrician in accordance with the National Electrical Code and relevant local code. Install this kit only in the luminaires that have the construction features and dimensions shown in the photographs and/or drawings.

WARNING - To prevent wiring damage or abrasion, do not expose wiring to edges of sheet metal or other sharp objects.

Do not make or alter any open holes in an enclosure of wiring or electrical components during kit installation.

WARNING - To avoid potential fire or shock hazard, do not use this retrofit kit in luminaires employing shunted bi-pin lamp holders. Note: Shunted lamp holders are found only in fluorescent luminaires with Instant-Start ballasts.

Instant-start ballasts can be identified by the words "Instant Start" or "I.S." marked on the ballast. This designation may

be in the form of a statement pertaining to the ballast itself, or may be combined with the marking for the lamps with

which the ballast is intended to be used, for example F40T12/IS. For more information, contact the LED luminaire retrofit kit manufacturer.

Installers should not disconnect existing wires from lamp holder terminals to make new connections at lamp holder

terminals. Instead installers should cut existing lamp holder leads away from the lamp holder and make new electrical

connections to lamp holder lead wires by employing applicable connectors. This device is not intended for use with emergency exits.

"This luminaire has been modified and can no longer operate the originally intended lamp," shall be marked on the retrofit luminaire where readily visible by the user during normal maintenance including re-lamping."

Suitable for use with NON-SHUNTED lamp holders only. See Diagram 1 below.

This item is rated at 120-277V. Installer must determine whether line voltage 120-277V is available at the luminaire

before installation.

Connect hot wire only to end cap with the L and N markings. Opposite end cap is dead, do not wire.

SUITABLE FOR DAMP LOCATIONS

4FT High Efficiency/High Output Type B T8 LED Installation Guide

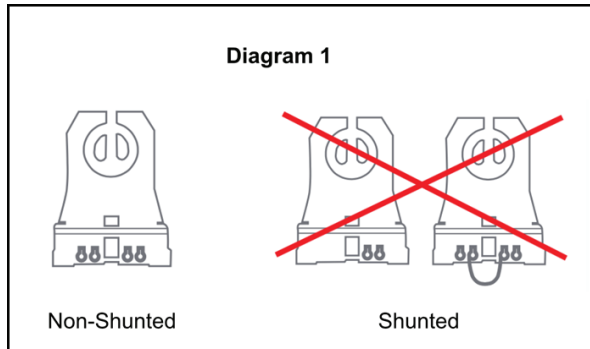

INSTALLATION GUIDE

1. Read all WARNINGS before continuing this section.
2. Ensure fixture is 120-277V.
3. Make sure POWER IS TURNED OFF AT THE SOURCE. Do not simply switch off fixture.
4. Remove existing covers from the light fixtures according to the light fixture manufacturer's instructions.
Carefully remove the existing fluorescent tubes and dispose of them according to federal, state and local laws.
5. Cut off wires connected to ballast, and remove ballast (and starter if present). Dispose of removed ballast according to federal, state and local laws.
6. If applicable, replace lamp holders at power end with non-shunted lamp holders.
7. Connect Live (L) from power source into non-shunted lamp holder "L In".
8. Connect Neutral (N) from power source into non-shunted lamp holder "N In".
9. If installing a single tube refer to Diagram 3 and go to section 13. If connecting multiple lamps, continue reading.
10. Connect separate hot wire into "Hot out" from primary source lamp holder and connect that wire into "Hot in" on the adjacent tube.
11. Connect separate neutral wire into "Neutral out" from primary source lamp holder and connect that wire into "Neutral in" on the adjacent tube. See Diagram 4 below.
12. Continue this process for additional lamps.
13. This device is powered on one end only, the end with L and N markings. See Diagram
14. Do not wire opposite end of lamp holder.
15. Install lamp with the L and N markings into the wired lamp holder end.
16. Visibly affix "Modification Sticker" to the fixture and reinstall housing cover and lens if applicable.
17. Return power back to source and installation is now completed.

4FT High Efficiency/High Output Type B T8 LED Installation Guide



Diagram 2 - Connecting End



Connecting power to end with L and N markings

Diagram 3 - Single Tube Wiring



Diagram 4 - Multiple Tube Wiring

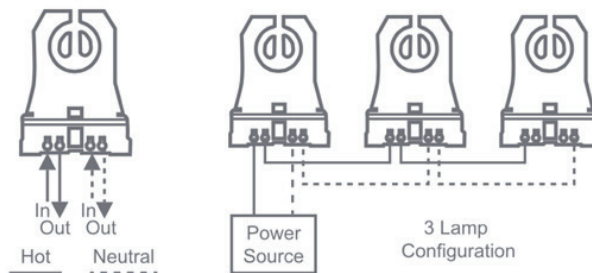

Warranty Information:

This product is warranted for five years from the date of purchase. If this product does not perform to the specifications supplied on this package, send an email or write to the address below for product return and replacement. This replacement is the sole remedy available. Liability for incidental or consequential damage is expressly excluded. Visit www.halcolighting.com for full warranty details and compatibility information.