

INSTALLATION & OPERATION INSTRUCTIONS

UNIVERSAL MOUNTING AND RED AND GREEN UNIVERSAL LED EXIT SIGN

BATTERY BACKUP

Package Contents

Part	Description	Quantity
1	LED Edge-Lit EXIT Sign	1
2	Recessed box and Bar hanger	1
3	Hardware Bag	1

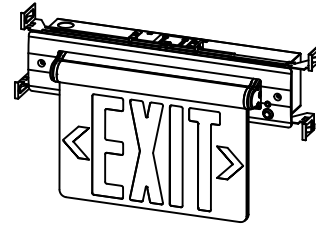

IMPORTANT SAFEGUARDS

READ AND FOLLOW ALL SAFETY INSTRUCTIONS.

When using electrical equipment, basic safety precautions should always be followed including the following

1. Before starting the installation, disconnect AC power by turning off the circuit breaker or by removing the appropriate fuse at the fuse box. Using the light switch to turning the power off is not sufficient to prevent electrical shock.
2. Do not use outdoors.
3. Do not mount near gas or electric heaters.
4. Use caution when servicing batteries. Battery acid can cause burns to skin and eyes. If acid is spilled on skin or eyes, flush acid with fresh water and contact a physician immediately.
5. Equipment should be mounted in locations and at heights where it will not be subjected to tampering by unauthorized personnel.
6. The use of accessory equipment not recommended by the manufacturer may cause an unsafe condition.
7. Do not use this equipment for other than its intended use.
8. All servicings should be performed by a qualified personnel only.
9. Allow battery to charge for 24 hours before first use.
10. Don't use alcohol or other detergents wipe or touch chevrons.

SAVE THESE INSTRUCTIONS

MAINTENANCE

Battery have to recharge if product keep in stock over 9 months, detail manual refer "BATTERY STOCK AND RECHARGE GUIDELINE". We recommend that the equipment be tested regularly in accordance with local codes. Replace the batteries as needed if discharge time do not achieve 90 minutes,

OPERATION

Press the test button, unit illuminance by battery backup and the LED indicator will turn off, release the test switch, LED indicator will turn on and the LED heads will turn off.

ELECTRICAL CONNECTIONS

- If using 120VAC, connect the black and white wires to the building utility.
- If using 277VAC, connect the orange and white wires to the building utility.
- Connect ground wires to building utility.
- Cap off unused wires. In all cases, use standard wire nuts in connection to wires.

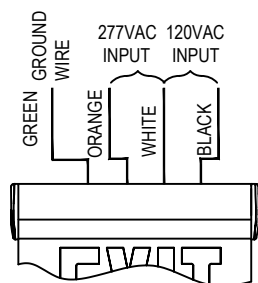

DETERMINE DIRECTION

- If need chevron indicator, remain chevron and remove instruction film.
- If no need chevron indicator, remove chevron and instruction film together.



RED AND GREEN COLOR CHANGEABLE

1. This product default setting is red color.
2. Slide the knob of slider switch to another side, then change to green color.

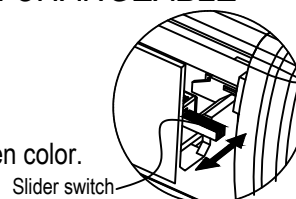

▲ NOTICE-MUST WEAR GLOVES FOR ALL INSTALLATION PROCESSES

Recessed Mounting

1. Use screwdriver open front cover and connect battery connector. feed the AC wires out of housing.
2. Red exit sign can change to green exit sign if need (See RED AND GREEN COLOR CHANGEABLE).

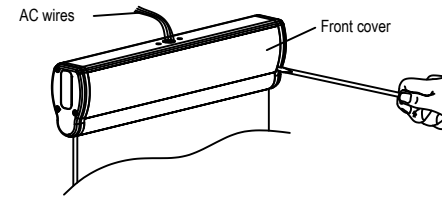

3. Unscrew and remove one end cap (test switch side), disconnect test switch and LED indicator connector, remove test switch and LED indicator /LED bushing for next step, through test switch and LED indicator wires out of end cap, restore end cap on housing by screws.

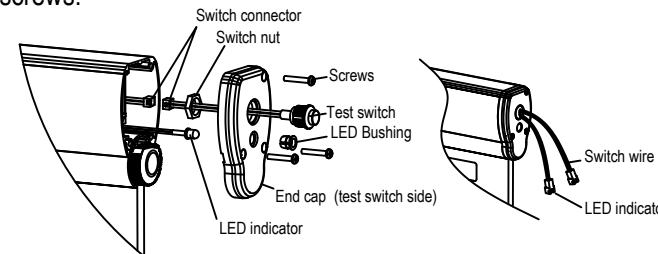

4. Unscrew and remove trim plate from metal box, snap LED bushing on the trim plate, assemble test switch and LED indicator on the trim plate.

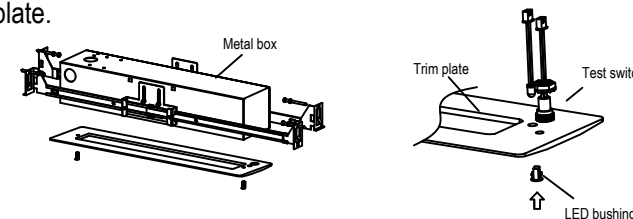

5. Pry off J-box cover by flat screw driver, punch out appropriate hole for AC wires feed in.

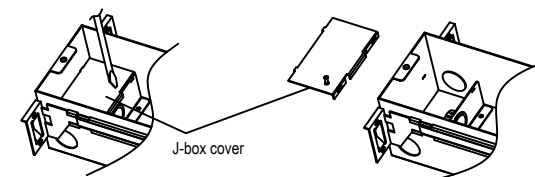

6. Cut a 14-5/8" x 3-1/4" opening in the ceiling or wall, ensure the opening dimensions need to less than the trimplate dimensions 15-3/4"x 4".

7. Position recessed kits and bar hangers between joists. Make sure bar hangers to be hanged in the right position. Position recessed kits temporarily by hammering "nail-in" tabs on bar hangers, then secure permanently with nails. Bar hangers should be level with bottom of joists. For T-bar installation, hang the ends of the hanger bars over the vertical part of the T-bar.

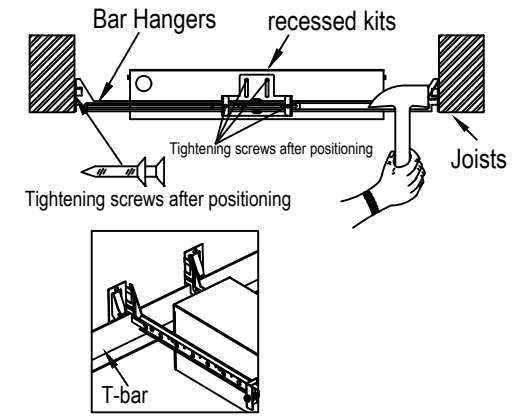

8. Adjust height of recessed kits vertically using adjusting slots and then tightening all screws on adjusting slots and bar hanger bracket to secure adjusting bracket and bar hangers.

9. Feed AC wires from fixture inside of J-box, make proper electrical connections at J-box in the metal housing, refer "ELECTRICAL CONNECTIONS". Restore J-box cover after wire connections, insert one side first and snap in another side.

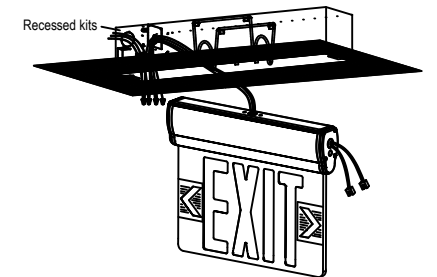

10. Insert fixture into metal box and snap by spring, connect test switch and LED indicator, notice the wires color should be match. Fix trim plate on the metal box by 2 screws.

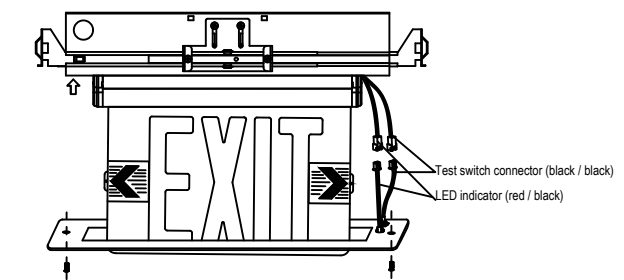

11. For wall recessed mounting, acrylic panel is available for rotational, peer off protective film from acrylic panel.

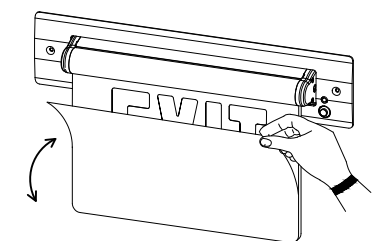

12. Determine direction for chevron indicator. (See DETERMINE DIRECTION)

Notice: Alcohol or other irritant detergent is not allowed to clean the acrylic panel.

▲ NOTICE-MUST WEAR GLOVES FOR ALL INSTALLATION PROCESSES

Surface Ceiling & Wall Mounting

1. Attach crossbar to junction box.(TM8#-32*-1)
2. Use screwdriver open front cover to connect battery connector.
3. Red exit sign can change to green exit sign if need (See *RED AND GREEN COLOR CHANGEABLE*).

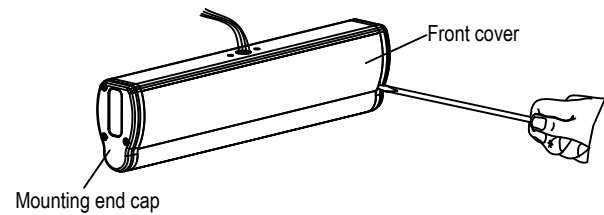

4. Feed AC supply wires through canopy center hole.
5. Assemble canopy onto main body assembly with (2) PM4*12 screws(supplied) and make proper wire connections.
(See *ELECTRICAL CONNECTIONS*).

6. Use (2) PM4-40 screws (supplied) tighten canopy to crossbar.

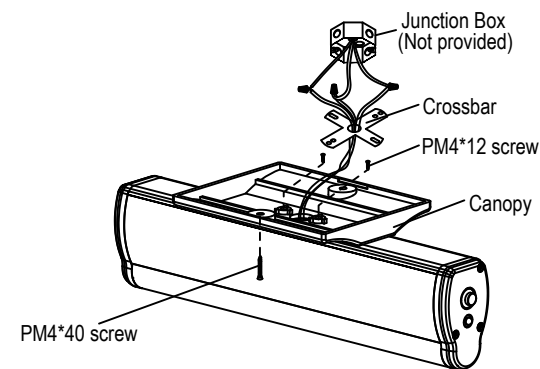

7. Insert EXIT panel into main body assembly gently. If EXIT panel is for single face, make sure EXIT letter direction is right, peer off protective film from acrylic panel.

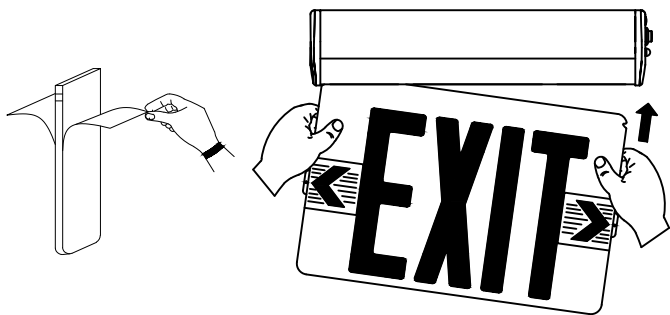

8. Determine direction for chevron placement.
(See *DETERMINE DIRECTION*)

9. The unit can be installed on any surface, you may rotate the EXIT panel in any angle from 0° to 180°, Ceiling mounting rotate 90° become Wall mounting.

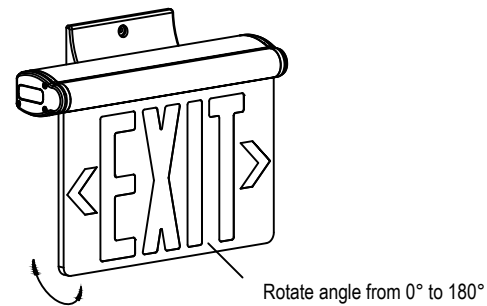

Notice: Alcohol or other irritant detergent is not allowed to clean the acrylic panel.

Surface End Mounting

1. Attach crossbar to junction box.
2. Use screwdriver open front cover to connect battery connector.
3. Red exit sign can change to green exit sign if need
(See *RED AND GREEN COLOR CHANGEABLE*).
4. Remove the hole plug from mounting end cap.
5. Pull out all AC supply wires and feed wires thru the center holes of mounting end cap and then canopy.
6. Reference 5 - 9 step in surface ceiling & wall mounting above for surface end mounting.

