

Halco®

LIGHTING TECHNOLOGIES

LED Retrofit Downlights

Incandescent Appliance/Fan

LED Direct Fit Slim Downlights

Linear Hybrid, Emergency, Hybrid T8

Traditional Incandescent Decorative

Next Generation A19, BR, PAR Lamps

ProLED Select Gimbal Downlight

LED SekTor Area Lights

LED Volumetric Panels

LED Backlit Panels

LED Edgelit Panels

LED SekTor Flood Lights

Traditional Fluorescents

LED Commercial Downlights

Traditional Metal Halide

2', 3', 4', 8' LED T8s

LED HID Retrofits

LED Wallpacks

LED Round Highbays

Traditional CFL Lamps

LED Linear Highbays

RESIDENTIAL
COMMERCIAL
INDUSTRIAL

**SEE OUR NEW
BALLAST
SECTION**



Scan to view the digital guide

Spring – Summer 2024

Look for This Icon to See Our New Products!



LAMPS 8THS INCHES

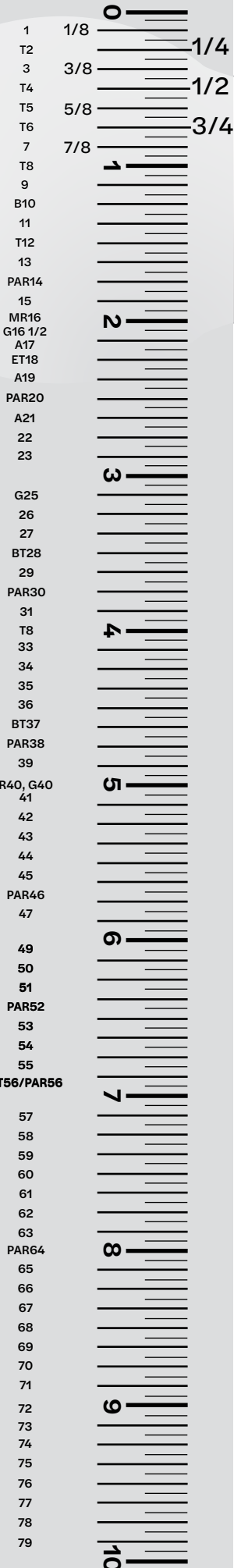

A19 example

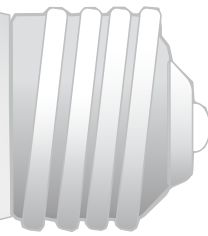

Questions about lighting?
Please call

1-800-677-3334

Customer Service is Ready to Help

Measure your Lamps Here

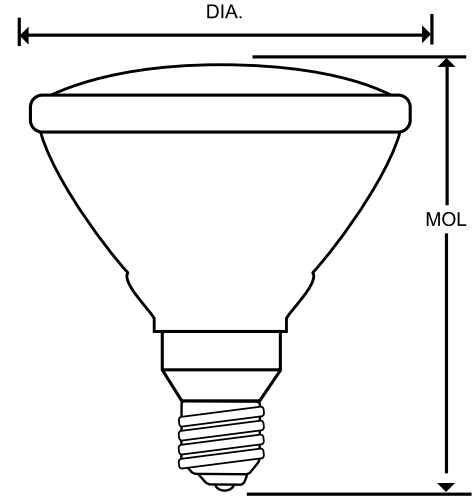
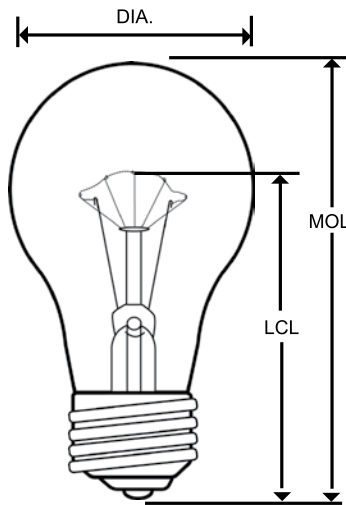

How To Measure A Lamp

DIA: The diameter of a bulb at its widest point, measured in eighths of an inch.

MOL: Maximum Overall Length from the top of the bulb to the bottom of the base, measured in inches.

LCL: Distance from the center of the light source to the bottom of the base, measured in inches.

Filament Lamp Construction

Special chemicals are applied inside lamp and on the filament to protect against premature failure.

Long life lamps utilize five filament supports to enhance longevity and guard against filament sagging and breakage.

Argon and Nitrogen gases are used for washing and filling lamps.

Lamp bases made with brass or nickel-plated brass do not freeze or corrode in the socket.

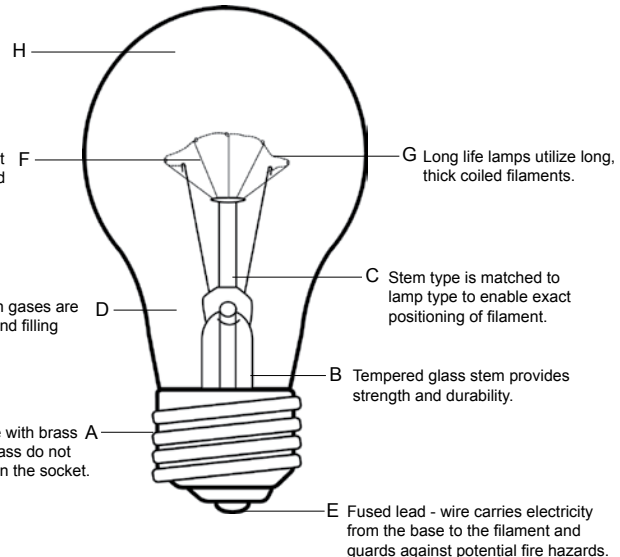

Long life lamps utilize long, thick coiled filaments.

Stem type is matched to lamp type to enable exact positioning of filament.

Tempered glass stem provides strength and durability.

Fused lead - wire carries electricity from the base to the filament and guards against potential fire hazards.

OUTDOOR FIXTURES

- ProLED Vaportight Series 4
- ProLED Select WPS Wallpack Series 4
- ProLED Sektor Dusk to Dawn Series 5
- ProLED Select SekurPak Wallpack Series 5
- ProLED Select Adjustable Wallpack 5
- ProLED Select Floodlight Series 6
- ProLED High Lumen Floodlight 6
- ProLED Select SekTor Floodlight Series 7
- Patrol Security Floodlight 8
- Mini Bullet Flood Light 8
- ProLED Select Slim Canopy 8
- ProLED SekTor Area Lights 9

INDOOR FIXTURES

- Emergence Series Combination Exit Sign/EM 11
- Edgelit Exit Series 11
- Emergence Series Exit Sign 11
- Evade Exit Series 12
- Evade Exit/Emergency Combination 12
- Evade Emergency Light Series 13
- Evade Emergency Wallpack 13
- ProLED Select Linear Strip Fixture 14
- ProLED Linear Strip 14
- ProLED Select Linear Architectural Wrap 14
- ProLED Linear Wrap 15
- ProLED Lamp Ready Fixture Strip 15
- ProLED Lamp Ready Fixture Wrap 15
- ProLED Select Linear Vaportight 16
- ProLED HLVT Linear Vaportight 16
- ProLED Select HoverBay Round Highbay ... 16
- ProLED Essential Round Highbay Series 17
- ProLED Essential Linear Highbay Series 18
- ProLED Select Compact Linear Highbay Series 19
- ProLED Premium Linear Highbay Series 22
- ProLED Select Linear Highbay Series 22
- ProLED Select Edgelit Flat Panel: Field Selectable Light Output & CCT 23
- ProLED Edgelit Flat Panel 23
- Surface Mount Kit 23
- ProLED Select Backlit Panel 24
- ProLED Select Volumetric Panel Series 24
- ProLED Select Commercial Downlight 25
- ProLED Commercial Downlight Retrofit 25
- ProLED Downlight Retrofit 25
- ProLED Select Retrofit Downlight Series 26
- ProLED Select Direct fit Gimbal Downlight... 27
- ProLED Select Gimbal Downlight Series 27
- ProLED Select Surface Downlight Retrofit... 27
- ProLED Surface Downlight Retrofit 27
- ProLED Select Slim Downlight Series 27
- ProLED Select Slim Downlight Series 4 Pk. 28
- ProLED Select Direct Fit Slim Downlights ... 28
- ProLED Square Downlight 29
- ProLED Select Flushmount Fixtures 29

LED LAMPS

- ProLED HID Highbay Replacement Lamp ... 31
- ProLED HID Wallpack Retrofit Series 31
- ProLED HID Omni Retrofit Series 31
- ProLED Select HID Retrofit Series 31

- ProLED Temporary Work Light 32
- ProLED T8 Type B 96in 42W Color Selectable 32
- ProLED Linear T8 (Type A) 32
- ProLED T8 8ft Linear Double Ended Bypass 33
- ProLED T8 Linear Double Ended Bypass Series (Type B) 33
- ProLED T8 Linear Double, Single Ended Bypass Series (Type B) 33
- Emergency T8 (Type B) 33
- ProLED Linear T8 Hybrid (Type A/B) 34
- ProLED Select T8 Linear Hybrid (Type A/B) 34
- ProLED T8 U-Bend Hybrid (Type A/B) 34
- ProLED T5 Direct Fit Replacement (Type A) 34
- ProLED T5 Single End Bypass Series 34
- ProLED A19 ECO Series 35
- ProLED A19 Contractor Series 6-Pk Gen 5 35
- ProLED A19 Contractor Series 6-Pk 36
- ProLED A19 Omnidirectional A-Shape Series (GU24 Base) 36
- ProLED A19 GU24 Base Contractor & Performance Series Lamp (Gen-5) 36
- ProLED A19 Omnidirectional A-Shape 37
- ProLED A19 Performance Lamp Title 20 (Gen-5) 37
- ProLED A15 Contractor & Performance Series Lamp (Gen-5) 38
- ProLED Performance A-Shape (Title 20) 38
- ProLED Performance A-Shape Lamp Title 24/JA 8 & Title 20 39

PAR & R Performance, Essential Series

- Product Selector 39
- ProLED BR40 40
- ProLED BR40 Essential 40
- ProLED BR40 Performance 40
- ProLED BR30 41
- ProLED BR30 Essential 41
- ProLED BR30 Contractor Series 6-Pack 41
- ProLED BR30 Essential 6-Pack 41
- ProLED BR30 Performance 42
- ProLED R20 42
- ProLED R20 Essential 42
- ProLED R20 Performance 42
- ProLED Prime PAR Series 43
- ProLED ECO PAR Series 44
- ProLED PAR20 Essential 45
- ProLED PAR30 Essential 45
- ProLED PAR38 Essential 45
- ProLED Performance PAR Lamps 46
- ProLED PAR20 Performance Lamps 46
- ProLED PAR30 Performance Lamps 47
- ProLED PAR38 Performance Lamps 48
- ProLED MR11 48
- ProLED Outdoor PAR36 48
- ProLED PAR36/AR111 Indoor 49
- Linear LED Plug-In series 49
- ProLED Plugin Series 49
- ProLED PL Bypass Series 50
- ProLED Plugin Series 50
- ProLED PL Hybrid Series 50
- ProLED Hybrid Plugin CCT Series 50
- ProLED Decorative Chandelier 51

- ProLED G25 Series Globe 51
- ProLED Filament LED Series 51
- ProLED B11 Chandelier 52
- ProLED Sign Lamp Series 53
- ProLED Elevator Lamp 53
- ProLED MR16 GU10 53
- ProLED MR16 54
- ProLED Commercial MR16/MR11 55
- ProLED MR16 Black 55
- ProLED IP Rated LED JC Series 56
- ProLED Omnidirectional IP65 JC Lamps 56
- ProLED Traditional JC Series 57
- ProLED Traditional LED Series 57

TRADITIONAL LIGHTING

- Compact Fluorescent Lamps Spiral 59
- Compact Fluorescent Lamps 2 Pin/4 Pin 60
- Compact Fluorescent Lamps High Lumen 4-Pin 61
- Compact Fluorescent Lamps Tube 2 Pin/4 Pin... 61
- Covershield Linear T5/T8 Tubes 62
- Covershield BR40 Lamps 62
- Covershield R40 Flood Lamps 63
- Covershield MH Lamps 63
- MH11 Halogen Flood Lamps 63
- MH16 Halogen Flood Lamps 64
- Covershield JC Halogen Lamps 64
- HID Lamps 66
- HID High Pressure Sodium Lamps 67
- HID MH Coated 67
- HID MH Pulse Start Lamps 67
- HID MH Double/Single/Standard 69
- Incandescent Lamps A15/A19 70
- Incandescent Lamps R40 71
- Incandescent Lamps BR30 71
- Incandescent Lamps BR38 71
- Incandescent Lamps PS30 Elongated 72
- Incandescent Lamps G25 Globe 72
- Incandescent Lamps R14/R20 Flood 72
- Incandescent Lamps S11/14 Sign/Appliance. 73
- Incandescent Lamps S6 Candelabra 73
- Incandescent T10/T6/T6.5/T7/T8 Tubes 74
- Fluorescent Tube F18 T8 Appliance/F32T8 Blacklight 74
- Fluorescent Tube Circleline 75
- Fluorescent Tube F T5/T12 75
- Fluorescent Tube FX T5 76
- Fluorescent Tube U-Bend T12/T8 79
- Incandescent Miniature Bayonet/Wedge 80
- Incandescent Decorative Clear Flame Tip ... 80
- Incandescent Decorative Globe 81
- Incandescent Decorative Torpedo 81

BULB & BASE IDENTIFICATION

- Led 82
- Compact Fluorescent 83
- Incandescent 84
- Halogen 85
- HID 86
- Specialty 87
- Linear Fluorescent 88

BALLAST GUIDE 89

- Ballast Sample List Inside Back Cover

About Halco Lighting Technologies

Established in 1974, Halco Lighting Technologies is a leader in lamp, luminaire and ballast solutions. We are dedicated to providing you with the latest in energy efficient technologies, illustrated by our ProLED luminaires and full offering of ProLED lamps. Halco's luminaire offering features indoor recessed solutions such as ProLED Panel, Volumetric Panel and Downlight Retrofit luminaires. Our broad selection of long life, energy efficient ProLED lamps is available in popular shapes with an array of color temperatures and beam spreads. Halco is your single source for LED lamps for replacement and retrofit applications.

Service

We measure our success by one standard - your satisfaction. Halco carries deep inventory of a broad SKU offering to assure we have what you need when you need it. With strategically located warehouses in Atlanta, Chicago, Cleveland, Houston, Los Angeles and Phoenix, orders placed by 2:00 PM local warehouse time ship the same day. Will-call and courier service is also available for your convenience.



How to Read Ordering Information

Product Number

Use this product number when placing an order

Color Temp.

A term used to describe the color of a light source and is expressed in degrees Kelvin (K)

Useful Life

Rated at L70

MOL

Indicates maximum overall length in inches

Description
Light Distribution or other important information

Base
Indicates base type

Lumens
Represents average light output

Package Quantity

Indicates minimum sell quantity and smallest shipping carton

ENERGY STAR®/DLC Qualified
Designates a qualified product

Product #	Product Code	Description	Wattage	Base	Voltage	Color Temp.	CRI	Lumens	CBCP	Useful Life ¹	Dimmable ²	Pkg. Qty.	Beam Spread	MOL	Eq. Wattage	ENERGY STAR®/DLC Qualified ³
81074	PAR36WFL4/827/IP67/LED	Wide Flood	4.5W	MP Term	10-15V	2700K	82	300	700	40,000	Yes	1/6	32°	2.40"	20W	No
81075	PAR36WFL6/827/IP67/LED	Wide Flood	6.5W	MP Term	10-15V	2700K	82	450	1100	40,000	Yes	1/6	32°	2.40"	35W	No
81076	PAR36WFL12/827/IP67/LED	Wide Flood	12.5W	MP Term	10-15V	2700K	82	800	2000	40,000	Yes	1/6	32°	2.40"	50W	No

SPEC SHEET AVAILABLE HERE.

Spec Sheet Available Here.
Link to corresponding product spec sheet.

Product Code
Abbreviated product description can also be used for ordering

Wattage
Indicates the power consumed by the lamp during operation

Voltage
Indicates the product's design voltage of operation

CRI
Lamps ability to render an object's color

CBCP
Luminous intensity at the center of the beam

Dimmable
Designates if product can be dimmed

Beam Spread
Indicates the beam angle or beam spread of a bulb, measured in degrees

Eq. Wattage
Typical wattage of Incandescent or Halogen lamp of comparable light output



NEW PRODUCT
Indicates product has been added to inventory

Customer Support

Our customer support team is available to assist for project and volume pricing. Contact your local rep for more information 1-800-677-3334.

¹ Useful Life is defined as the point in time at which the LED will maintain at least 70% of its initial lumens. The LED will continue to operate past this point at decreased light levels.

² May not be compatible with all Dimming systems, Dimming performance may vary by system. Please check www.halcolighting.com for up-to-date dimmer compatibility information. Use on incompatible systems may shorten lamp life.

³ To view our DLC qualified products, please consult the DLC Qualified Products List at www.designlights.org/qpl.

OUTDOOR FIXTURES



ProLED Select WPFS
Wallpack Series



ProLED High Lumen
Floodlight



ProLED SekTor
Area Light Series



ProLED Select
Slim Canopy





[SPEC SHEET AVAILABLE HERE.](#)

ProLED Vaportight Series



Product #	Product Code	Wattage	Voltage	Color Temp.	CRI	Lumens	Useful Life ¹	Wet Location	Eq. Wattage	ENERGY STAR [®]
10455	VPT-20-4K-U	20W	120-277V	4000K	>80	1,915	50,000	Yes	100W PSMH	Yes
10456	VPT-20-5K-U	20W	120-277V	5000K	>80	2,198	50,000	Yes	100W PSMH	Yes

[SPEC SHEET AVAILABLE HERE.](#)

ProLED Select WPS Wallpack Series



Product #	Product Code	Wattage	Voltage	Color Temp.	CRI	Lumens	Useful Life ¹	Dimmable ²	DLC Qualified ³
10390	WPS-28-4K-U	28W	120-277V	4000K	80	3,514	50,000	Yes	Yes
10391	WPS-28-5K-U	28W	120-277V	5000K	80	3,609	50,000	Yes	Yes
10392	WPS-40-4K-U	40W	120-277V	4000K	80	4,885	50,000	Yes	Yes
10393	WPS-40-5K-U	40W	120-277V	5000K	80	4,948	50,000	Yes	Yes
10394	WPS-80-4K-U	80W	120-277V	4000K	80	9,797	50,000	Yes	Yes
10395	WPS-80-5K-U	80W	120-277V	5000K	80	9,865	50,000	Yes	Yes
10396	WPS-120-4K-U	120W	120-277V	4000K	80	14,228	50,000	Yes	Yes
10397	WPS-120-5K-U	120W	120-277V	5000K	80	14,465	50,000	Yes	Yes

Available Accessories

Product #	Product Code	Description
10141	PC/120-277V	Button Photocell, 120-277VAC



SPEC SHEET AVAILABLE HERE.

Sektor Dusk to Dawn



Sektor



Product #	Product Code	Wattage	Voltage	Color Temp.	CRI	Lumens	Useful Life	Equivalent Wattage	DLC Qualified
24845	SDD-WS-CS-U-GR-3PR	28W-40W-60W	120-347V	3000K, 4000K, 5000K Selectable	70	4,000-8,700	50,000	125W - 200W MH	Yes
24846	SDD-40-50-U-GR-3PR	40W	120-347V	5000K	70	5,400	50,000	175 MH	Yes

Available Accessories

Product #	Product Code	Description
10261	SDD-90	Sektor Dusk To Dawn 90 Degree Mounting Arm Gray Aluminum

● Indicates new products added

SPEC SHEET AVAILABLE HERE.

ProLED Select SekurPak Wallpack Series



Product #	Product Code	Wattage	Voltage	Color Temp.	CRI	Lumens	Useful Life ¹	Dimmable ²	Eq. Wattage	DLC Qualified ³
10450	SKWP-15-FS-U	15W	120-277V	3000K,4000K, 5000K	80	1,941, 2,061, 2,024	50,000	0-10V	100W MH	Yes
10451	SKWP-20-FS-U	20W	120-277V	3000K, 4000K, 5000K	80	2,456, 2,651, 2,551	50,000	0-10V	150W PSMH	Yes
10452	SKWP-26-FS-U	26W	120-277V	3000K, 4000K, 5000K	80	3,239, 3,484, 3,263	50,000	0-10V	175W MH	Yes

SPEC SHEET AVAILABLE HERE.

ProLED Select Adjustable Wallpack



Product #	Product Code	Wattage	Voltage	Color Temp.	CRI	Lumens	Useful Life ¹	Dimmable ²	Eq. Wattage	DLC Qualified ³
39874	AWP-1-15-CS-U-PC	15W	120-277V	3000K, 4000K, 5000K	80	1,761-1,904	>100,000	Yes	50W MH	Premium
39875	AWP-2-WS-CS-U-PC	15W-20W-30W	120-277V	3000K, 4000K, 5000K	80	2,138-3,902	>100,000	Yes	50W-100W MH	Premium
39876	AWP-3-WS-CS-U-PC	30W-40W-50W	120-277V	3000K, 4000K, 5000K	80	3,877-7,016	>100,000	Yes	100W-175W MH	Premium
39877	AWP-4-WS-CS-U-PC	60W-70W-80W	120-277V	3000K, 4000K, 5000K	80	8,032-11,144	>100,000	Yes	175W-250W MH	Premium
39878	AWP-5-WS-CS-U-PC	100W-110W-120W	120-277V	3000K, 4000K, 5000K	80	13,110-16,738	>100,000	Yes	250W-400W MH	Premium



SPEC SHEET AVAILABLE HERE.

ProLED Select Flood Series



Product #	Product Code	Wattage	Voltage	Color Temp.	CRI	Lumens	Useful Life ¹	Dimmable ²	Eq. Wattage	DLC Qualified ³
10339	FLFS12/3CCTU/KN	12W	120-277V	3000K, 4000K, 5000K	70	1,560	50,000	No	50W MH	Yes
10340	FLFS12/3CCTU/YK	12W	120-277V	3000K, 4000K, 5000K	70	1,560	50,000	No	50W MH	Yes
10341	FLFS30/3CCTU/KN	30W	120-277V	3000K, 4000K, 5000K	70	3,900	50,000	No	100W MH	Yes
10342	FLFS30/3CCTU/YK	30W	120-277V	3000K, 4000K, 5000K	70	3,900	50,000	No	100W MH	Yes
10343	FLFS50/3CCTU/KN	50W	120-277V	3000K, 4000K, 5000K	70	6,500	50,000	No	150W MH	Yes
10344	FLFS50/3CCTU/YK	50W	120-277V	3000K, 4000K, 5000K	70	6,500	50,000	No	150W MH	Yes
10345	FLFS70/3CCTU/SF	70W	120-277V	3000K, 4000K, 5000K	70	9,100	50,000	0-10V	175W MH	Yes
10346	FLFS70/3CCTU/YK	70W	120-277V	3000K, 4000K, 5000K	70	9,100	50,000	0-10V	175W MH	Yes
10347	FLFS100/3CCTU/SF	100W	120-277V	3000K, 4000K, 5000K	>70	13,000	50,000	0-10V	250W PSMH	Yes
10348	FLFS100/3CCTU/YK	100W	120-277V	3000K, 4000K, 5000K	>70	13,000	50,000	0-10V	250W PSMH	Yes

SPEC SHEET AVAILABLE HERE.

ProLED High Lumen Floodlight



Product #	Product Code	Wattage	Voltage	Color Temp.	CRI	Lumens	Useful Life ¹	Dimmable ²	Eq. Wattage	DLC Qualified ³
10349	FL150/U50/SF	150W	120-277V	5000K	>70	19,500	>100,000	0-10V	400W MH	Yes
10350	FL150/U50/YK	150W	120-277V	5000K	>70	19,500	>100,000	0-10V	400W MH	Yes

Available Accessories

Product #	Product Code	Description
10141	PC/120277	Button Photocell, 120-277V



SekTor



SPEC SHEET AVAILABLE HERE.

ProLED Select SekTor Floodlights Series

Product #	Product Code	Wattage	Voltage	Color Temp.	CRI	Lumens	Useful Life ¹	Dimmable ²	DLC Qualified ³
24900	SFL-150-CS-U-TR	150W	120-277V	3000K, 4000K, 5000K	70	18, 236-20, 552	50,000	Yes	Yes
24901	SFL-150-CS-U-KN	150W	120-277V	3000K, 4000K, 5000K	70	18, 236-20, 552	50,000	Yes	Yes
24902	SFL-200-CS-U-TR	200W	120-277V	3000K, 4000K, 5000K	70	25, 162-28, 382	50,000	Yes	Yes
24903	SFL-200-CS-U-KN	200W	120-277V	3000K, 4000K, 5000K	70	25, 162-28, 382	50,000	Yes	Yes
24904	SFL-300-40-U-TR	300W	120-277V	4000K	70	42,761	50,000	Yes	Yes
24905	SFL-300-40-U-KN	300W	120-277V	5000K	70	42,761	50,000	Yes	Yes
24906	SFL-300-50-U-TR	300W	120-277V	4000K	70	43,184	50,000	Yes	Yes
24907	SFL-300-50-U-KN	300W	120-277V	5000K	70	43,184	50,000	Yes	Yes

ProLED Select Flood Series Fixture Options

Product #	Product Code	Description
24910	SEK-SPD	Sektor 10 kVA Surge Protection Device
24911	SFL-3PR	Sektor Flood 3 Pin Photocell Extension & Shorting Cap

Product #	Product Code	Description
24915	SFL-VSR-M	Sektor Visor 150W & 200W Fixture
24916	SFL-VSR-L	Sektor Visor 300W Fixture
24917	SFL-WGD-M	Sektor Wireguard 150W & 200W Fixture
24918	SFL-WGD-L	Sektor Wireguard 300W Fixture
10231	PC/JL205C	Photocell Twist Lock 120 277VAC JI 205c



SPEC SHEET AVAILABLE HERE.

Patrol Security Floodlight



Product #	Product Code	Wattage	Voltage	Color Temp.	CRI	Lumens	Useful Life	Dimmable	Equivalent Wattage
24954	PFL-20-30-U-BZ	20W	120-277V	3000K	80	2,800	30,000	No	100W MH
24955	PFL-20-30-U-WH	20W	120-277V	3000K	80	2,800	30,000	No	100W MH
24956	PFL-20-50-U-BZ	20W	120-277V	5000K	80	2,800	30,000	No	100W MH
24957	PFL-20-50-U-WH	20W	120-277V	5000K	80	2,800	30,000	No	100W MH

SPEC SHEET AVAILABLE HERE.

Mini Bullet Floodlight



Product #	Product Code	Wattage	Voltage	Color Temp.	CRI	Lumens	Useful Life	Dimmable	Equivalent Wattage
24950	MBUL-10-30-U-BZ	10W	120-277V	3000K	80	1,200	30,000	Yes	50W MH
24951	MBUL-10-30-U-BL	10W	120-277V	3000K	80	1,200	30,000	Yes	50W MH
24952	MBUL-10-50-U-BZ	10W	120-277V	5000K	80	1,200	30,000	Yes	50W MH
24953	MBUL-10-50-U-BL	10W	120-277V	5000K	80	1,200	30,000	Yes	50W MH

SPEC SHEET AVAILABLE HERE.

ProLED Select Slim Canopy



Product #	Product Code	Wattage	Voltage	Color Temp.	CRI	Lumens	Useful Life ¹	Dimmable ²	Eq. Wattage	DLC Qualified ³
Parking Garage Distribution										
39900	CSP-28-CS-U-BZ	28W	120-347V	3000K, 4000K, 5000K	70	3,500-3,780	>100,000	0-10V	150W MH	Premium
39901	CSP-40-CS-U-BZ	40W	120-347V	3000K, 4000K, 5000K	70	5,000-5,400	>100,000	0-10V	175W MH	Premium
39902	CSP-60-CS-U-BZ	60W	120-347V	3000K, 4000K, 5000K	70	7,500-8,100	>100,000	0-10V	250W MH	Premium
39904	CSP-28-CS-U-WH	28W	120-347V	3000K, 4000K, 5000K	70	3,500-3,780	>100,000	0-10V	150W MH	Premium
39905	CSP-40-CS-U-WH	40W	120-347V	3000K, 4000K, 5000K	70	5,000-5,400	>100,000	0-10V	175W MH	Premium
39906	CSP-60-CS-U-WH	60W	120-347V	3000K, 4000K, 5000K	70	7,500-8,100	>100,000	0-10V	250W MH	Premium



SPEC SHEET AVAILABLE HERE.

ProLED SekTor Area Lights
Ordering Logic

EX: SAL-200-T3-40-U-7PR



Series	Wattage	Distribution	CCT	Voltage	Options
SAL = SekTor Area Light	100 = 100 Watts 150 = 150 Watts 200 = 200 Watts 240 = 240 Watts 300 = 300 Watts	T2 = Type II* T3 = Type III T4 = Type IV* T5 = Type V	40 = 4000K 50 = 5000K	U = 120 277 VAC H = 347-480 VAC*	7PR = 7 Pin Receptacle w/Photocell* SPD = 10kVA Surge Suppression*

* For Options and Non-Stock Items - Lead Times Apply ** Mounting Ordered Separately

Product #	Product Code	Wattage	Voltage	Color Temp.	CRI	Lumens	Useful Life ¹	Dimmable ²	Eq. Wattage	DLC Qualified
24850	SAL-100-T3-40-U	100W	100-277V	4000K	70	14,556-14,851	100,000	0-10V	250W	Yes
24851	SAL-100-T5-40-U	100W	100-277V	4000K	70	14,556-14,851	100,000	0-10V	250W	Yes
24852	SAL-100-T3-50-U	100W	100-277V	5000K	70	14,556-14,851	100,000	0-10V	250W	Yes
24853	SAL-100-T5-50-U	100W	100-277V	5000K	70	14,556-14,851	100,000	0-10V	250W	Yes
24854	SAL-150-T3-40-U	150W	100-277V	4000K	70	21,641-21,935	100,000	0-10V	400W	Yes
24855	SAL-150-T5-40-U	150W	100-277V	4000K	70	21,641-21,935	100,000	0-10V	400W	Yes
24856	SAL-150-T3-50-U	150W	100-277V	5000K	70	21,641-21,935	100,000	0-10V	400W	Yes
24857	SAL-150-T5-50-U	150W	100-277V	5000K	70	21,641-21,935	100,000	0-10V	400W	Yes
24858	SAL-200-T3-40-U	200W	100-277V	4000K	70	29,112-29,886	100,000	0-10V	400W	Yes
24859	SAL-200-T5-40-U	200W	100-277V	4000K	70	29,112-29,886	100,000	0-10V	400W	Yes
24860	SAL-200-T3-50-U	200W	100-277V	5000K	70	29,112-29,886	100,000	0-10V	400W	Yes
24861	SAL-200-T5-50-U	200W	100-277V	5000K	70	29,112-29,886	100,000	0-10V	400W	Yes
24862	SAL-240-T3-40-U	240W	100-277V	4000K	70	34,601-35,076	100,000	0-10V	750W	Yes
24863	SAL-240-T5-40-U	240W	100-277V	4000K	70	34,601-35,076	100,000	0-10V	750W	Yes
24864	SAL-240-T3-50-U	240W	100-277V	5000K	70	34,601-35,076	100,000	0-10V	750W	Yes
24865	SAL-240-T5-50-U	240W	100-277V	5000K	70	34,601-35,076	100,000	0-10V	750W	Yes
24866	SAL-300-T3-40-U	300W	100-277V	4000K	70	43,734-43,884	100,000	0-10V	1000W	Yes
24867	SAL-300-T5-40-U	300W	100-277V	4000K	70	43,734-43,884	100,000	0-10V	1000W	Yes
24868	SAL-300-T3-50-U	300W	100-277V	5000K	70	43,734-43,884	100,000	0-10V	1000W	Yes
24869	SAL-300-T5-50-U	300W	100-277V	5000K	70	43,734-43,884	100,000	0-10V	1000W	Yes

Available Accessories

Product #	Product Code	Description
Fixture Accessories*		
24875	DCMS	Dc Motion Bi-Level Motion Sensor
24876	DCMS-REM	Dc Motion Bi-Level Motion Sensor Remote
24878	SAL-BLS-SM	Sektor Backlight Shield (100W-150W)
24879	SAL-BLS-L	Sektor Backlight Shield (200W-300W)
24880	SAL-SS-SM	Sektor Side Shield (100W-150W)
24881	SAL-SS-L	Sektor Side Shield (200W-300W)
24975	DCMSPIR	DC Bi-Level PIR (Passive Infrared) Motion Sensor
Mounting Arms		
24870	SEK-SF	Sektor Slipfit Knuckle Mount
24871	SEK-QM	Sektor Straight Arm Quick Mount
24872	SEK-TR	Sektor Trunnion Mount
24908	SEK-PM	Sektor Adjustable Pole Mount

● Indicates new products added

INDOOR FIXTURES

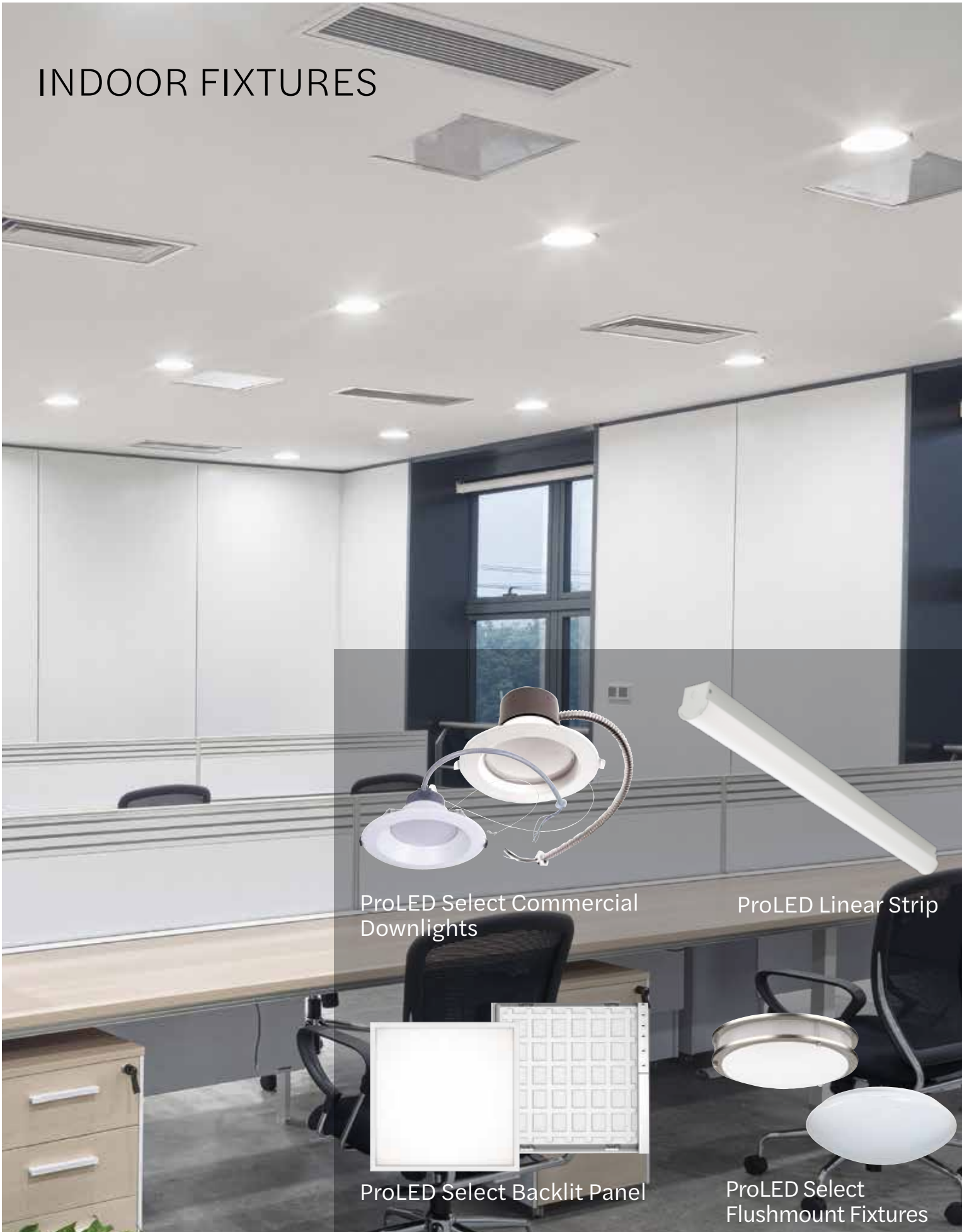

ProLED Select Commercial Downlights

ProLED Linear Strip

ProLED Select Backlit Panel

ProLED Select Flushmount Fixtures



SPEC SHEET AVAILABLE HERE.

Emergence Series Combination Exit Sign/EM Unit



Product #	Product Code	Product Description
Exit Signs		
97102	EMG-EXC-WH-RG	Emergence Series, White Thermoplastic Combination Exit Sign/Emergency Unit, Universal Red/Green, Universal Single/Double Face, Universal Mounting
97103	EMG-EXC-WH-RG-RC	Emergence Series, White Thermoplastic Combination Exit Sign/Emergency Unit, Universal Red/Green, Universal Single/Double Face, Universal Mounting, Remote Capacity
Remote Heads		
95010	EV-RH-1-IND	Evade Single Remote Indoor Round Head
95011	EV-RH-2-IND	Evade Double Remote Indoor Round Head
97012	EV2-RH-1-OUT-RD	Evade Single Remote Outdoor Round Head
97013	EV2-RH-2-OUT-RD	Evade Double Remote Outdoor Round Head

SPEC SHEET AVAILABLE HERE.

Edgelit Exit series



Product #	Product Code	Product Description
97104	EMG-EDG-AL-RG	Emergence Series, Aluminum Edgelit Exit, Universal Red/Green, Universal Single/Double Face, Universal Mounting

SPEC SHEET AVAILABLE HERE.

Emergence Series Exit Sign



Product #	Product Code	Product Description
Exit Signs		
97100	EMG-EXE-WH-RG	Emergence Series, White Thermoplastic Exit Sign, Universal Red/Green, Universal Single/Double Face, Universal Mounting
97101	EMG-EXE-WH-RG-RC	Emergence Series, White Thermoplastic Exit Sign, Universal Red/Green, Universal Single/Double Face, Universal Mounting, Remote Capacity
Remote Heads		
95010	EV-RH-1-IND	Evade Single Remote Indoor Round Head
95011	EV-RH-2-IND	Evade Double Remote Indoor Round Head
97012	EV2-RH-1-OUT-RD	Evade Single Remote Outdoor Round Head
97013	EV2-RH-2-OUT-RD	Evade Double Remote Outdoor Round Head



SPEC SHEET AVAILABLE HERE.

Evade Exit Series



Product #	Product Code	Product Description
Exit Signs		
95000	EV-EXE-GR	Evade Exit Sign with Green Lettering
95002	EV-EXE-GR-RC	Evade Exit Sign with Green Lettering With Remote Capacity
95003	EV-EXE-RD-RC	Evade Exit Sign with Red Lettering With Remote Capacity
Remote Heads		
95015	EV-RHE-1-IND	Evade Single Indoor Square Remote Head
95016	EV-RHE-2-IND	Evade Double Indoor Square Remote Head
96012	EV-RH-1-OUT	Evade Single Outdoor Round Remote Head

SPEC SHEET AVAILABLE HERE.

Evade Exit/Emergency Combination Series



Product #	Product Code	Product Description
Exit Signs		
95004	EV-EXC-GR	Evade Exit & Em Combo Green Lettering
95005	EV-EXC-RD	Evade Exit & Em Combo Red Lettering
95006	EV-EXC-GR-RC	Evade Exit & Em Combo Green Lettering With Remote Capacity
95007	EV-EXC-RD-RC	Evade Exit & Em Combo Red Lettering With Remote Capacity
Remote Heads		
95010	EV-RHE-1-IND	Evade Single Remote Indoor Head
95011	EV-RHE-2-IND	Evade Dual Remote Indoor Head
96012	EV-RH-1-OUT	Evade Single Remote Outdoor Head



[SPEC SHEET AVAILABLE HERE.](#)

Evade Emergency Light Series



Product #	Product Code	Product Description
Exit Signs		
95008	EV-EME-R	Evade Emergency Unit
95009	EV-EME-R-RC	Evade Emergency With Remote Capacity
Remote Heads		
95010	EV-RHE-1-IND	Evade Single Remote Indoor Head
95011	EV-RHE-2-IND	Evade Dual Remote Indoor Head
96012	EV-RH-1-OUT	Evade Single Remote Outdoor Head
97012	EV2-RH-1-OUT-RD	Evade Single Remote Outdoor Round Head
97013	EV2-RH-2-OUT-RD	Evade Double Remote Outdoor Round Head

[SPEC SHEET AVAILABLE HERE.](#)

Evade Emergency Wallpack



Product #	Product Code	Product Description
Exit Signs		
95014	EV-EME-R-RC	Evade Emergency With Remote Capacity



SPEC SHEET AVAILABLE HERE.

ProLED Select Linear Strip Fixture



Product #	Product Code	Wattage	Voltage	Color Temp	CRI	Lumens	Useful Life	Dimmable	DLC Qualified
90241	LS4-WS-CS-U	30W, 40W, 50W	120-277VAC	3500K, 4000K, 5000K	80	4,532-6,997	50,000	0-10V	Yes
90242	LS8-WS-CS-U	50W, 60W, 70W	120-277VAC	3500K, 4000K, 5000K	80	7,504-9,712	50,000	0-10V	Yes

Available Accessories

Product #	Product Code	Description
90243	LS-SK-1	ProLED Select Linear Strip Suspension Kit Size 1 4ft
90244	LS-SK-2	ProLED Select Linear Strip Suspension Kit Size 2 8ft
90245	LS-SM-CK-1	ProLED Select Linear Strip Surface Mount Connector Kit Size 1 4ft
90246	LS-SM-CK-2	ProLED Select Linear Strip Surface Mount Connector Kit Size 2 8ft
90247	LS-SK-CK-1	ProLED Select Linear Strip Suspension Connector Kit Size 1 4ft
90248	LS-SK-CK-2	ProLED Select Linear Strip Suspension Connector Kit Size 2 8ft
80313	MWMS-BRI810	Microwave Motion Sensor Sharkward Bri810-M10
99986	LHB/MC/PIR	Motion Sensor Control Pir LSXR 610 HI
90313	BBU/EM9WU	Emergency Battery Back Up 9W 120-277V 90 Minute 0-10V Dimming

SPEC SHEET AVAILABLE HERE.

ProLED Linear Strip



Product #	Product Code	Wattage	Voltage	Color Temp.	CRI	Lumens	Useful Life ¹	Dimmable ²	Equivalent Wattage	DLC Qualified ³
10240	LS4/36U40	36W	120-277V	4000K	80	4,903	100,000	0-10V	(2) 32W T8	Yes
10241	LS4/36U50	36W	120-277V	5000K	80	4,910	100,000	0-10V	(2) 32W T8	Yes
10243	LS8/72U40	72W	120-277V	4000K	80	9,806	100,000	0-10V	(2) 59W T8	Yes
10244	LS8/72U50	72W	120-277V	5000K	80	9,820	100,000	0-10V	(2) 59W T8	Yes

Available Accessories

Product #	Product Code	Description
10228	LS4/LENS	Linear Strip; 4ft Acrylic Lens
10229	LS8/LENS	Linear Strip; 8ft Acrylic Lens
10309	LS-LCK	Linear Strip; Linear Connection Kit
10310	BBU/EM8WU	Battery Backup; Emergency 8W, 120-277V, 90 Minute Backup
10311	ACC/12IN	Aircraft Cable; 12 Inches, 1 Set
10318	MWMS/IB/MC601V	Microwave Motion Sensor; Installation Bracket; Merrytek MC601V
10313	MWMS/MC601V	Microwave Motion Sensor; Merrytek MC601V

SPEC SHEET AVAILABLE HERE.

ProLED Select Linear Architectural Wrap



Product #	Product Code	Description
90380	LWA-2-WS-CS-U	ProLED Select Linear Wrap 2ft Selectable Wattage and CCT 120-277VAC
90381	LWA-4-WS-CS-U	ProLED Select Linear Wrap 4ft Selectable Wattage and CCT 120-277VAC

Accessories

90382	LWA-SK-VH	ProLED Select Linear Wrap Suspension Kit with V Hook
90385	LWA-45-MB	ProLED Select Linear Wrap 45 Degree Mounting Bracket
90386	LWA-EC	ProLED Select Linear Wrap Replacement End Caps No Knock Out

Options

90382	LWA-SK-VH	ProLED Select Linear Wrap Suspension Kit with V Hook
90385	LWA-45-MB	ProLED Select Linear Wrap 45 Degree Mounting Bracket
90386	LWA-EC	ProLED Select Linear Wrap Replacement End Caps No Knock Out
90313	BBU/EM9WU	Battery Backup Emergency 9W 120-277V 90 Minute 0-10V Dimming



SPEC SHEET AVAILABLE HERE.

ProLED Linear Wrap



Product #	Product Code	Wattage	Voltage	Color Temp.	CRI	Lumens	Useful Life ¹	Dimmable ²	Equivalent Wattage	DLC Qualified ³
Traditional Prismatic Lens										
10302	LWA-P20U2-40	20W	120-277V	4000K	80	2,442	50,000	0-10V	(2) 17W T8	Yes
10307	LWA-P20U2-50	20W	120-277V	5000K	80	2,466	50,000	0-10V	(2) 17W T8	Yes
10299	LWA-P40U4-40	40W	120-277V	4000K	80	4,944	50,000	0-10V	(2) 32W T8	Yes
10304	LWA-P40U4-50	40W	120-277V	5000K	80	5,008	50,000	0-10V	(2) 32W T8	Yes
Architectural Diffused Lens										
10300	LWA-D23U2-40	23W	120-277V	4000K	80	3,073	100,000	0-10V	(2) 17W T8	Yes
10305	LWA-D23U2-50	23W	120-277V	5000K	80	3,125	100,000	0-10V	(2) 17W T8	Yes
10301	LWA-D46U4-40	46W	120-277V	4000K	80	6,242	100,000	0-10V	(2) 32W T8	Yes
10306	LWA-D46U4-50	46W	120-277V	5000K	80	6,293	100,000	0-10V	(2) 32W T8	Yes

Available Accessories

Product #	Product Code	Description
10310	BBU/EM8WU	Battery Backup; Emergency 8W, 120-277V, Lipf04 Battery, 90 Minute Backup
10311	ACC/12IN	Aircraft Cable; 12", 1 Set
10312	LWA-D/JB	Linear Wrap; Architectural Diffused Lens; Joiner Bracket, 1 Pair (2pcs)
10313	MWMS/MC601V	Microwave Motion Sensor; Merrytek MC601V
10318	MWMS/IB/MC601V	Microwave Motion Sensor; Installation Bracket; Merrytek MC601V

SPEC SHEET AVAILABLE HERE.

ProLED Lamp Ready Fixture Strip Series



Product #	Product Code	Description
90510	LRS2-2L-T8DE	Lamp Ready Fixture Strip 2ft 2 Lamp Double End Bypass Lamp
90511	LRS4-2L-T8DE	Lamp Ready Fixture Strip 4ft 2 Lamp Double End Bypass Lamp
90515	LRS8-4L-T8DE	Lamp Ready Fixture Strip 8ft 4 Lamp Double End Bypass Lamp

Available Accessories

Product #	Product Code	Description
90514	LRS-JB	Lamp Ready Fixture Strip Joiner Bracket

SPEC SHEET AVAILABLE HERE.

ProLED Lamp Ready Fixture Wrap Series



Product #	Product Code	Description
90512	LRW2-2L-T8DE	Lamp Ready Fixture Wrap 2ft 2 Lamp Double End Bypass Lamp
90513	LRS4-2L-T8DE	Lamp Ready Fixture Wrap 4ft 2 Lamp Double End Bypass Lamp



[SPEC SHEET AVAILABLE HERE.](#)

ProLED Select Linear Vaportight Series



Product #	Product Code	Wattage	Voltage	Color Temp.	CRI	Lumens	Useful Life ¹	Dimmable ²	Wet Location	DLC Qualified ³
28090	LVPT-2-WS-CS-U	20W, 25W, 30W	120-277V	3000K, 4000K, 5000K	80	2,780, 3,600, 4,140	75,000	0-10V	Yes	Yes
28091	LVPT-4-WS-CS-U	40W, 50W, 60W	120-277V	3000K, 4000K, 5000K	80	5,600, 7,300, 8,280	75,000	0-10V	Yes	Yes
28092	LVPT-8-WS-CS-U	60W, 75W, 80W	120-277V	3000K, 4000K, 5000K	80	8,340, 10,875, 12,450	75,000	0-10V	Yes	Yes

Available Accessories

Product #	Product Code	Description
28094	LVPT-MS-RC	LVPT Dc Microwave Motion Sensor Remote Control
28095	LVPT-ACC	LVPT Suspended Aircraft Cable Mounting Accessory, 9 Foot Length
28096	LVPT-RPL-LENS-2	LVPT Replacement Lens 2ft Length
28097	LVPT-RPL-LENS-4	LVPT Replacement Lens 4ft Length
28098	LVPT-RPL-LENS-8	LVPT Replacement Lens 8ft Length
28099	LVPT-MTG-HDWR	LVPT Spare Mounting Hardware

[SPEC SHEET AVAILABLE HERE.](#)

ProLED HLVT Linear Vaportight Series



Product #	Product Code	Wattage	Voltage	Color Temp.	CRI	Lumens	Useful Life ¹	Dimmable ²	Eq. Wattage	DLC Qualified ³
10316	HLVT4/40U40	40W	120-277V	4000K	80	5,200	100,000	0-10V	3 x 32W T8	Yes
10317	HLVT4/40U50	40W	120-277V	5000K	80	5,200	100,000	0-10V	3 x 32W T8	Yes

Available Accessories

Product #	Product Code	Description
10311	ACC/12IN	Aircraft Cable; 12", 1 Set
40500	BBU/EM10W	BBU/EM10W 40500 Emergency 10W

[SPEC SHEET AVAILABLE HERE.](#)

ProLED Select HoverBay Round Highbay Series



Product #	Product Code	Wattage	Voltage	Color Temp.	CRI	Lumens	Useful Life	Dimmable	Equivalent Wattage	DLC Qualified
30250	HRHB-100-CS-U-WH	100W	120-277V	4000K, 5000K	80	14,703-14,280	100,000	0-10V	250W MH	Yes
30251	HRHB-100-CS-U-BL	100W	120-277V	4000K, 5000K	80	14,703-14,280	100,000	0-10V	250W MH	Yes
30252	HRHB-150-CS-U-WH	150W	120-277V	4000K, 5000K	80	20,831-20,940	100,000	0-10V	400W MH	Yes
30253	HRHB-150-CS-U-BL	150W	120-277V	4000K, 5000K	80	20,831-20,940	100,000	0-10V	400W MH	Yes
30254	HRHB-200-CS-U-WH	200W	120-277V	4000K, 5000K	80	28,942-29,179	100,000	0-10V	600W MH	Yes
30255	HRHB-200-CS-U-BL	200W	120-277V	4000K, 5000K	80	28,942-29,179	100,000	0-10V	600W MH	Yes
30256	HRHB-240-CS-U-WH	240W	120-277V	4000K, 5000K	80	33,212-33,282	100,000	0-10V	750W MH	Yes
30257	HRHB-240-CS-U-BL	240W	120-277V	4000K, 5000K	80	33,212-33,282	100,000	0-10V	750W MH	Yes

Continue to next page for additional product information



Available Accessories

Product #	Product Code	Description
24875*	DCMS	DC Bi-Level Motion Sensor
24876	DCMS-REM	DC Bi-Level Motion Sensor Remote
24975	DCMSPIR	DC Bi-Level PIR (Passive Infrared) Motion Sensor
30258	HRHB-YB-SM-B	Hoverbay Round Highbay Yoke Mount Bracket - 100W & 150W Fixtures (Black)
30259	HRHB-YB-LG-B	Hoverbay Round Highbay Yoke Mount Bracket - 200W & 240W Fixtures (Black)
30274	HRHB-YB-SM-W	Hoverbay Round Highbay Yoke Mount Bracket - 100W & 150W Fixtures (White)
30275	HRHB-YB-LG-W	Hoverbay Round Highbay Yoke Mount Bracket - 200W & 240W Fixtures (White)
30260	HRHB-JBM	Hoverbay Round Highbay Junction Box Mount
30269	HRHB-PA	Hoverbay Round Highbay Pendant Adapter
30273*	HRHB-BBU-30	Hoverbay Round Highbay Em Pack 30 Watt
30261	HRHB-AR-SM	Hoverbay Round Highbay Aluminum Reflector - 100W & 150W Fixtures
30262	HRHB-AR-LG	Hoverbay Round Highbay Aluminum Reflector - 200W & 240W Fixtures
30263	HRHB-PC-SM	Hoverbay Round Highbay Polycarbonate Reflector - 100W & 150W Fixtures
30264	HRHB-PC-LG	Hoverbay Round Highbay Polycarbonate Reflector - 200W & 240W Fixtures
30265	HRHB-FL-SM	Hoverbay Round Highbay 110 Degree Frosted Lens - 100W & 150W Fixtures
30266	HRHB-FL-LG	Hoverbay Round Highbay 110 Degree Frosted Lens - 200W & 240W Fixtures
30278	HRHB-110-SM	Hoverbay Round Highbay 110 Degree Clear Lens - 100W & 150W Fixtures
30279	HRHB-110-LG	Hoverbay Round Highbay 110 Degree Clear Lens - 200W & 240W Fixtures
30267	HRHB-60-SM	Hoverbay Round Highbay 60 Degree Lens - 100W & 150W Fixtures
30268	HRHB-60-LG	Hoverbay Round Highbay 60 Degree Lens - 200W & 240W Fixtures
30276	HRHB-WG-SM	Hoverbay Round Highbay Wire Guard - 100W & 150W Fixtures
30277	HRHB-WG-LG	Hoverbay Round Highbay Wire Guard - 200W & 240W Fixtures

*When using HRHB-BBU-EM battery and DCMS Motion Sensor, DCMS sensor must be set to standby time on the motion sensor remote. This setting allows fixture to not turn off in EM mode.

● Indicates new products added

SPEC SHEET AVAILABLE HERE.

ProLED Essential Round Highbay Series



Product #	Product Code	Wattage	Voltage	Color Temp.	CRI	Lumens	Useful Life	Dimmable	Equivalent Wattage	DLC Qualified
37300	ERHB-100-50-U	100W	120-277V	5000K	80	14000	50,000	0-10V	250W MH	Yes
37301	ERHB-150-50-U	150W	120-277V	5000K	80	21000	50,000	0-10V	250W MH	Yes
37302	ERHB-200-50-U	200W	120-277V	5000K	80	28000	50,000	0-10V	400W MH	Yes
37303	ERHB-240-50-U	240W	120-277V	5000K	80	33000	50,000	0-10V	400W MH	Yes

Available Accessories

Product #	Product Code	Description
37304	ERHB-PC	Essential Round Highbay Polycarbonate Reflector
37305	ERHB-AL	Essential Round Highbay Aluminum Reflector
37306	ERHB-WG	Essential Round Highbay Wire Guard
37307	ERHB-YB	Essential Round Highbay Yoke Mount Bracket
37308	ERHB-PA	Essential Round Highbay Pendant Mount Adapter



SPEC SHEET AVAILABLE HERE.

ProLED Essential Linear Highbay Series



Product #	Product Code	Wattage	Voltage	Color Temp.	CRI	Lumens	Useful Life ¹	Dimmable ²	Eq. Wattage	DLC Qualified ³
36104	ECLHB-110-50-U	110W	120-277V	5000K	≥80	14,960	50,000	Yes	26W	Yes
36105	ECLHB-220-50-U	220W	120-277V	5000K	≥80	29,920	50,000	Yes	26W	Yes

Available Accessories

Product #	Product Code	Description
24875*	DCMS	DC Bi-Level Motion Sensor
24975	DCMSPIR	DC Bi-Level PIR (Passive Infrared) Motion Sensor
24876	DCMS-REM	DC Bi-Level Motion Sensor Remote
99986	LHB/MC	(0-10V) Motion Control Sensor LSXR 610 HL - Side Knockout Install
36148	CLHB-1-A-WG	Wire Guard for ECLHB-110
36150	CLHB-34-A-WG	Wire Guard for ECLHB-220
36151	CLHB-12-M-PEND	Pendant Mount for ECLHB-110
36152	CLHB-12-M-SURF	Surface Mount for ECLHB-110
36153	CLHB-34-M-PEND	Pendant Mount for ECLHB-220
36154	CLHB-34-M-SURF	Surface Mount for ECLHB-220
36155	CLHB-BBU-9	Battery Backup (9W/90Min) ECLHB
36156	CLHB-12-DR-480V	Driver (150W) 277-480VAC for ECLHB-110
36157	CLHB-3-DR-480V	Driver (200W) 277-480VAC for ECLHB-220

*When using CLHB-BBU-9 or 16 and DCMS Motion Sensor, DCMS sensor must be set to ∞ standby time on the motion sensor remote. This setting allows fixture to not turn off in EM mode.

Non Stock Product #	Product Code	Description
36134	ECLHB-110-50-U-PIRMS	ProLED Essential Compact Linear Highbay 110W 5000K, Universal Voltage 120-277VAC with Suspended Chain Mount with PIR Motion Sensor
36135	ECLHB-110-50-U-EM	ProLED Essential Compact Linear Highbay 110W 5000K, Universal Voltage 120-277VAC with Suspended Chain Mount with Emergency Battery Backup
36136	ECLHB-110-50-U-EM-PIRMS	ProLED Essential Compact Linear Highbay 110W 5000K, Universal Voltage 120-277VAC with Suspended Chain Mount with Emergency Battery Backup and PIR Motion Sensor
36137	ECLHB-110-50-H	ProLED Essential Compact Linear Highbay 110W 5000K, Universal Voltage 277-480VAC with Suspended Chain Mount
36138	ECLHB-110-50-H-PIRMS	ProLED Essential Compact Linear Highbay 110W 5000K, Universal Voltage 277-480VAC with Suspended Chain Mount with PIR Motion Sensor
36139	ECLHB-110-50-H-EM	ProLED Essential Compact Linear Highbay 110W 5000K, Universal Voltage 277-480VAC with Suspended Chain Mount with Emergency Battery Backup
36140	ECLHB-110-50-H-EM-PIRMS	ProLED Essential Compact Linear Highbay 110W 5000K, Universal Voltage 277-480VAC with Suspended Chain Mount with Emergency Battery Backup and PIR Motion Sensor
36141	ECLHB-220-50-U-PIRMS	ProLED Essential Compact Linear Highbay 220W 5000K, Universal Voltage 120-277VAC with Suspended Chain Mount with PIR Motion Sensor
36142	ECLHB-220-50-U-EM	ProLED Essential Compact Linear Highbay 220W 5000K, Universal Voltage 120-277VAC with Suspended Chain Mount with Emergency Battery Backup
36143	ECLHB-220-50-U-EM-PIRMS	ProLED Essential Compact Linear Highbay 220W 5000K, Universal Voltage 120-277VAC with Suspended Chain Mount with Emergency Battery Backup and PIR Motion Sensor
36144	ECLHB-220-50-H	ProLED Essential Compact Linear Highbay 220W 5000K, Universal Voltage 277-480VAC with Suspended Chain Mount
36145	ECLHB-220-50-H-PIRMS	ProLED Essential Compact Linear Highbay 220W 5000K, Universal Voltage 277-480VAC with Suspended Chain Mount with PIR Motion Sensor
36146	ECLHB-220-50-H-EM	ProLED Essential Compact Linear Highbay 220W 5000K, Universal Voltage 277-480VAC with Suspended Chain Mount with Emergency Battery Backup
36147	ECLHB-220-50-H-EM-PIRMS	ProLED Essential Compact Linear Highbay 220W 5000K, Universal Voltage 277-480VAC with Suspended Chain Mount with Emergency Battery Backup and PIR Motion Sensor



Controls

Product #	Product Code	Description
Motion Sensor / PIR Sensor:		
99986	LHB/MC	(0-10V) Motion Control Sensor LSXR 610 HL - Side Knockout Install
DC Motion Sensor / PIR Sensor:		
24975	DCMSPIR	DC Bi-Level PIR (Passive Infrared) Motion Sensor, order minimum one remote (24876) per site
24875	DCMS	DC Bi-Level Motion Sensor, order minimum one remote (24876) per site
24876	DCMS-REM	DC Bi-Level Motion Sensor Remote

Available Accessories

Product #	Product Code	Description
36148	CLHB-1-A-WG	Wire Guard for ECLHB-110
36150	CLHB-34-A-WG	Wire Guard for ECLHB- 220
36151	CLHB-12-M-PEND	Pendant Mount for ECLHB- 220
36152	CLHB-12-M-SURF	Surface Mount for ECLHB-110
36153	CLHB-34-M-PEND	Pendant Mount for ECLHB- 220
36154	CLHB-34-M-SURF	Surface Mount for ECLHB- 220
36155	CLHB-BBU-9	Battery Backup (9W/90Min) for ECLHB-110 and ECLHB- 220
36156	CLHB-12-DR-480V	Driver (150W) 277-480VAC for ECLHB- 220
36158	CLHB-4-DR-480V	Driver (320W) 277-480VAC for ECLHB- 220

SPEC SHEET AVAILABLE HERE.

ProLED Select Compact Linear Highbay Series



Product #	Product Code	Wattage	Voltage	Color Temp.	CRI	Lumens	Useful Life ¹	Dimmable ²	DLC Qualified ³
36100	CLHB-1-WS-CS-U	90W, 110W, 130W	120-277V	4000K/ 5000K	≥80	12,010-17,588	50,000	Yes	Yes
36101	CLHB-2-WS-CS-U	140W, 150W, 165W	120-277V	4000K/ 5000K	≥80	19,859-23,736	50,000	Yes	Yes
36102	CLHB-3-WS-CS-U	180W, 200W, 220W	120-277V	4000K/ 5000K	≥80	24,540-31,023	50,000	Yes	Yes
36103	CLHB-4-WS-CS-U	240W, 280W, 320W	120-277V	4000K/ 5000K	≥80	32,450-45,237	50,000	Yes	Yes

Available Accessories

Product #	Product Code	Description
24875*	DCMS	DC Bi-Level Motion Sensor
24975	DCMSPIR	DC Bi-Level PIR (Passive Infrared) Motion Sensor
24876	DCMS-REM	DC Bi-Level Motion Sensor Remote
99986	LHB/MC	(0-10V) Motion Control Sensor LSXR 610 HL - Side Knockout Install
36148	CLHB-1-A-WG	Wire Guard for CLHB-1
36149	CLHB-2-A-WG	Wire Guard for CLHB-2
36150	CLHB-34-A-WG	Wire Guard for CLHB- 3, CLHB-4

*When using CLHB-BBU-9 or 16 and DCMS Motion Sensor, DCMS sensor must be set to ∞ standby time on the motion sensor remote. This setting allows fixture to not turn off in EM mode.

Continue to next page for additional product information



Available Accessories

Product #	Product Code	Description
36151	CLHB-12-M-PEND	Pendant Mount for CLHB-1, CLHB-2
36152	CLHB-12-M-SURF	Surface Mount for CLHB-1, CLHB-2
36152	CLHB-12-M-SURF	Surface Mount for CLHB-1, CLHB-2
36153	CLHB-34-M-PEND	Pendant Mount for CLHB-3 CLHB-4
36154	CLHB-34-M-SURF	Surface Mount for CLHB-3 CLHB-4
36155	CLHB-BBU-9	Battery Backup (9W/90Min) for CLHB
36156	CLHB-12-DR-480V	Driver (150W) 277-480VAC for CLHB-1 CLHB-2
36157	CLHB-3-DR-480V	Driver (200W) 277-480VAC for CLHB-3
36158	CLHB-4-DR-480V	Driver (320W) 277-480VAC for CLHB-4

Non Stock Product #	Product Code	Description
36106	CLHB-1-WS-CS-U-PIRMS	ProLED Select Compact Linear Highbay 1, Wattage Selectable 130W-110W-90W, Color Selectable 4000K-5000K, Universal Voltage 120-277VAC with Suspended Chain Mount with PIR Motion Sensor
36107	CLHB-1-WS-CS-U-EM	ProLED Select Compact Linear Highbay 1, Wattage Selectable 130W-110W-90W, Color Selectable 4000K-5000K, Universal Voltage 120-277VAC with Suspended Chain Mount with Emergency Battery Backup
36108	CLHB-1-WS-CS-U-EM-PIRMS	ProLED Select Compact Linear Highbay 1, Wattage Selectable 130W-110W-90W, Color Selectable 4000K-5000K, Universal Voltage 120-277VAC with Suspended Chain Mount with Emergency Battery Backup and PIR Motion Sensor
36109	CLHB-1-WS-CS-H	ProLED Select Compact Linear Highbay 1, Wattage Selectable 130W-110W-90W, Color Selectable 4000K-5000K, Universal Voltage 277-480VAC with Suspended Chain Mount
36110	CLHB-1-WS-CS-H-PIRMS	ProLED Select Compact Linear Highbay 1, Wattage Selectable 130W-110W-90W, Color Selectable 4000K-5000K, Universal Voltage 277-480VAC with Suspended Chain Mount with PIR Motion Sensor
36111	CLHB-1-WS-CS-H-EM	ProLED Select Compact Linear Highbay 1, Wattage Selectable 130W-110W-90W, Color Selectable 4000K-5000K, Universal Voltage 277-480VAC with Suspended Chain Mount with Emergency Battery Backup
36112	CLHB-1-WS-CS-H-EM-PIRMS	ProLED Select Compact Linear Highbay 1, Wattage Selectable 130W-110W-90W, Color Selectable 4000K-5000K, Universal Voltage 277-480VAC with Suspended Chain Mount with Emergency Battery Backup and PIR Motion Sensor
36113	CLHB-2-WS-CS-U-PIRMS	ProLED Select Compact Linear Highbay 2, Wattage Selectable 165W-150W-140W, Color Selectable 4000K-5000K, Universal Voltage 120-277VAC with Suspended Chain Mount with PIR Motion Sensor
36114	CLHB-2-WS-CS-U-EM	ProLED Select Compact Linear Highbay 2, Wattage Selectable 165W-150W-140W, Color Selectable 4000K-5000K, Universal Voltage 120-277VAC with Suspended Chain Mount with Emergency Battery Backup
36115	CLHB-2-WS-CS-U-EM-PIRMS	ProLED Select Compact Linear Highbay 2, Wattage Selectable 165W-150W-140W, Color Selectable 4000K-5000K, Universal Voltage 120-277VAC with Suspended Chain Mount with Emergency Battery Backup and PIR Motion Sensor
36116	CLHB-2-WS-CS-H	ProLED Select Compact Linear Highbay 2, Wattage Selectable 165W-150W-140W, Color Selectable 4000K-5000K, Universal Voltage 277-480VAC with Suspended Chain Mount
36117	CLHB-2-WS-CS-H-PIRMS	ProLED Select Compact Linear Highbay 2, Wattage Selectable 165W-150W-140W, Color Selectable 4000K-5000K, Universal Voltage 277-480VAC with Suspended Chain Mount with PIR Motion Sensor
36118	CLHB-2-WS-CS-H-EM	ProLED Select Compact Linear Highbay 2, Wattage Selectable 165W-150W-140W, Color Selectable 4000K-5000K, Universal Voltage 277-480VAC with Suspended Chain Mount with Emergency Battery Backup
36119	CLHB-2-WS-CS-H-EM-PIRMS	ProLED Select Compact Linear Highbay 2, Wattage Selectable 165W-150W-140W, Color Selectable 4000K-5000K, Universal Voltage 277-480VAC with Suspended Chain Mount with Emergency Battery Backup and PIR Motion Sensor
36120	CLHB-3-WS-CS-U-PIRMS	ProLED Select Compact Linear Highbay 3, Wattage Selectable 220W-200W-180W, Color Selectable 4000K-5000K, Universal Voltage 120-277VAC with Suspended Chain Mount with PIR Motion Sensor
36121	CLHB-3-WS-CS-U-EM	ProLED Select Compact Linear Highbay 3, Wattage Selectable 220W-200W-180W, Color Selectable 4000K-5000K, Universal Voltage 120-277VAC with Suspended Chain Mount with Emergency Battery Backup
36122	CLHB-3-WS-CS-U-EM-PIRMS	ProLED Select Compact Linear Highbay 3, Wattage Selectable 220W-200W-180W, Color Selectable 4000K-5000K, Universal Voltage 120-277VAC with Suspended Chain Mount with Emergency Battery Backup and PIR Motion Sensor
36123	CLHB-3-WS-CS-H	ProLED Select Compact Linear Highbay 3, Wattage Selectable 220W-200W-180W, Color Selectable 4000K-5000K, Universal Voltage 277-480VAC with Suspended Chain Mount
36124	CLHB-3-WS-CS-H-PIRMS	ProLED Select Compact Linear Highbay 3, Wattage Selectable 220W-200W-180W, Color Selectable 4000K-5000K, Universal Voltage 277-480VAC with Suspended Chain Mount with PIR Motion Sensor

Continue to next page for additional product information



Non Stock Product #	Product Code	Description
36124	CLHB-3-WS-CS-H-PIRMS	ProLED Select Compact Linear Highbay 3, Wattage Selectable 220W-200W-180W, Color Selectable 4000K-5000K, Universal Voltage 277-480VAC with Suspended Chain Mount with PIR Motion Sensor
36125	CLHB-3-WS-CS-H-EM	ProLED Select Compact Linear Highbay 3, Wattage Selectable 220W-200W-180W, Color Selectable 4000K-5000K, Universal Voltage 277-480VAC with Suspended Chain Mount with Emergency Battery Backup
36126	CLHB-3-WS-CS-H-EM-PIRMS	ProLED Select Compact Linear Highbay 3, Wattage Selectable 220W-200W-180W, Color Selectable 4000K-5000K, Universal Voltage 277-480VAC with Suspended Chain Mount with Emergency Battery Backup and IR Motion Sensor
36127	CLHB-4-WS-CS-U-PIRMS	ProLED Select Compact Linear Highbay 4, Wattage Selectable 320W-280W-240W, Color Selectable 4000K-5000K, Universal Voltage 120-277VAC with Suspended Chain Mount with PIR Motion Sensor
36128	CLHB-4-WS-CS-U-EM	ProLED Select Compact Linear Highbay 4, Wattage Selectable 320W-280W-240W, Color Selectable 4000K-5000K, Universal Voltage 120-277VAC with Suspended Chain Mount with Emergency Battery Backup
36129	CLHB-4-WS-CS-U-EM-PIRMS	ProLED Select Compact Linear Highbay 4, Wattage Selectable 320W-280W-240W, Color Selectable 4000K-5000K, Universal Voltage 120-277VAC with Suspended Chain Mount with Emergency Battery Backup and PIR Motion Sensor
36130	CLHB-4-WS-CS-H	ProLED Select Compact Linear Highbay 4, Wattage Selectable 320W-280W-240W, Color Selectable 4000K-5000K, Universal Voltage 277-480VAC with Suspended Chain Mount
36131	CLHB-4-WS-CS-H-PIRMS	ProLED Select Compact Linear Highbay 4, Wattage Selectable 320W-280W-240W, Color Selectable 4000K-5000K, Universal Voltage 277-480VAC with Suspended Chain Mount with PIR Motion Sensor
36132	CLHB-4-WS-CS-H-EM	ProLED Select Compact Linear Highbay 4, Wattage Selectable 320W-280W-240W, Color Selectable 4000K-5000K, Universal Voltage 277-480VAC with Suspended Chain Mount with Emergency Battery Backup
36133	CLHB-4-WS-CS-H-EM-PIRMS	ProLED Select Compact Linear Highbay 4, Wattage Selectable 320W-280W-240W, Color Selectable 4000K-5000K, Universal Voltage 277-480VAC with Suspended Chain Mount with Emergency Battery Backup and PIR Motion Sensor

Controls

Product #	Product Code	Description
Motion Sensor / PIR Sensor:		
99986	LHB/MC	(0-10V) Motion Control Sensor LSXR 610 HL - Side Knockout Install
DC Motion Sensor / PIR Sensor:		
24975	DCMSPiR	DC Bi-Level PIR (Passive Infrared) Motion Sensor, order minimum one remote (24876) per site
24875	DCMS	DC Bi-Level Motion Sensor, order minimum one remote (24876) per site
24876	DCMS-REM	DC Bi-Level Motion Sensor Remote

Available Accessories

Product #	Product Code	Description
36148	CLHB-1-A-WG	Wire Guard for ECLHB-110
36149	CLHB-2-A-WG	Wire Guard for CLHB-2
36150	CLHB-34-A-WG	Wire Guard for ECLHB- 220
36151	CLHB-12-M-PEND	Pendant Mount for ECLHB- 220
36152	CLHB-12-M-SURF	Surface Mount for ECLHB-110
36153	CLHB-34-M-PEND	Pendant Mount for ECLHB- 220
36154	CLHB-34-M-SURF	Surface Mount for ECLHB- 220
36155	CLHB-BBU-9	Battery Backup (9W/90Min) for ECLHB-110 and ECLHB- 220
36156	CLHB-12-DR-480V	Driver (150W) 277-480VAC for ECLHB- 220
36157	CLHB-3-DR-480V	Driver (200W) 277-480VAC for CLHB-3
36158	CLHB-4-DR-480V	Driver (320W) 277-480VAC for ECLHB- 220

*When using CLHB-BBU-9 or 16 and DCMS Motion Sensor, DCMS sensor must be set to ∞ standby time on the motion sensor remote. This setting allows fixture to not turn off in EM mode.



SPEC SHEET AVAILABLE HERE.

ProLED Premium Linear Highbay Series

Quick Ship Product



Product Code	Product Code	Wattage	Voltage	Color Temp.	CRI	Lumens	Useful Life ¹	Dimmable ²	DLC Qualified ³
*10419	HLHB1/101U50	101W	120-277V	5000K	80	14,604	100,000	0-10V	Yes
*10420	HLHB2/161U50	161W	120-277V	5000K	80	22,862	100,000	0-10V	Yes

* Phasing out-while supplies last

Available Accessories

Product #	Product Code	Description
99986	LHB/MC	Motion Control Sensor LSXR 610 HL

SPEC SHEET AVAILABLE HERE.

ProLED Select Linear Highbay Series



Product #	Product Code	Wattage	Voltage	Color Temp.	CRI	Lumens	Useful Life	Dimmable	Equivalent Wattage	DLC Qualified
30280	LHB-1-WS-40-U	70W-90W-110W	120-277V	4000K	80	9,700-14,500	>100,000 Hrs	0-10VDC	4-lamp (T8), 175W HID	Yes
30281	LHB-1-WS-50-U	70W-90W-110W	120-277V	5000K	80	9,700-14,500	>100,000 Hrs	0-10VDC	4-lamp (T8), 175W HID	Yes
30282	LHB-2-WS-40-U	110W-135W-160W	120-277V	4000K	80	16,300-22,000	>100,000 Hrs	0-10VDC	4-lamp (T5HO), 6-lamp (T8), 250W-400W HID	Yes
30283	LHB-2-WS-50-U	110W-135W-160W	120-277V	5000K	80	16,300-22,000	>100,000 Hrs	0-10VDC	4-lamp (T5HO), 6-lamp (T8), 250W-400W HID	Yes
30284	LHB-3-WS-40-U	180W-200W-220W	120-277V	4000K	80	25,500-30,100	>100,000 Hrs	0-10VDC	6-lamp (T5HO), 8-lamp (T8), 400W-750W HID	Yes
30285	LHB-3-WS-50-U	180W-200W-220W	120-277V	5000K	80	25,500-30,100	>100,000 Hrs	0-10VDC	6-lamp (T5HO), 8-lamp (T8), 400W-750W HID	Yes
30286	LHB-4-WS-40-U	240W-280W-320W	120-277V	4000K	80	35,300-45,000	>100,000 Hrs	0-10VDC	8-lamp (T5HO) 750W-1000W HID	Yes
30287	LHB-4-WS-50-U	240W-280W-320W	120-277V	5000K	80	35,300-45,000	>100,000 Hrs	0-10VDC	8-lamp (T5HO) 750W-1000W HID	Yes

Available Accessories

Product #	Product Code	Description
30288	LHB-PMA	LHB Pendant Mounting Assembly For Wattage Selectable Lhb
30289	LHB-SMK-1	LHB Surface Mount Kit Assembly For Wattage Selectable LHB1, LHB2, LHB4
30290	LHB-SMK-2	LHB Surface Mount Kit Assembly For Wattage Selectable LHB3
30291	LHB-MWMS	LHB Microwave Motion Control Sensor
30292	LHB-MS-RC	LHB Microwave Motion Control Sensor Remote
99986	LHB/MC	Motion Control Sensor LSXR 610 HI
99654	LHB1&2-WG	Linear Highbay Wire Guard For LHB1 & LHB2
99655	LHB3-WG	Linear Highbay Wire Guard For LHB3
99656	LHB4-WG	Linear Highbay Wire Guard For LHB4



SPEC SHEET AVAILABLE HERE.

ProLED Select Edgelit Flat Panel: Field Selectable Light Output & CCT



Product #	Product Code	Wattage	Voltage	Color Temp.	CRI	Lumens	Useful Life ¹	Dimmable ²	Eq. Wattage	DLC Qualified ³
1' x 4'										
10330	14FSEPL/8DU	20W, 25W, 30W	120-277V	3000K, 4000K, 5000K	80	3,300-5,000	50,000	0-10V	(2) 32W T8	Yes
2' x 2'										
10331	22FSEPL8DU	40W, 50W, 60W	120-277V	3000K, 4000K, 5000K	80	3,300-5,000	50,000	0-10V	(2) 32W T8	Yes
2' x 4'										
10332	24FSEPL/8DU	60W, 75W, 80W	120-277V	3000K, 4000K, 5000K	80	3300-5,000	50,000	0-10V	(4) 32W T8	Yes

Available Accessories

Product #	Product Code	Description
81981	VPL/EM/LED3	Emergency Battery; 16W, 120-277V

SPEC SHEET AVAILABLE HERE.

ProLED Edgelit Flat Panel



Product #	Product Code	Wattage	Voltage	Color Temp.	CRI	Lumens	Useful Life ¹	Dimmable ²	Eq. Wattage	DLC Qualified ³
1' x 4"										
*81982	14EPL40/835/LED	40W	120-277V	3500K	82	4,000	50,000	0-10V	(2) 32W T8	Yes
*81984	14EPL40/850/LED	40W	120-277V	5000K	82	4,000	50,000	0-10V	(2) 32W T8	Yes
2' x 2'										
*81963	22EPL30/835/LED	30W	120-277V	3500K	82	3,000	50,000	0-10V	(2) 32W T8	Yes
*81964	22EPL30/840/LED	30W	120-277V	4000K	82	3,050	50,000	0-10V	(2) 32W T8	Yes
*81965	22EPL30/850/LED	30W	120-277V	5000K	82	3,150	50,000	0-10V	(2) 32W T8	Yes
2' x 4'										
*81966	24EPL50/835/LED	50W	120-277V	3500K	82	5000	50,000	0-10V	(4) 32W T8	Yes
*81967	24EPL50/840/LED	50W	120-277V	4000K	82	5100	50,000	0-10V	(4) 32W T8	Yes
*81968	24EPL50/850/LED	50W	120-277V	5000K	82	5300	50,000	0-10V	(4) 32W T8	Yes

* Phasing out-while supplies last

SPEC SHEET AVAILABLE HERE.

Surface Mount Kit

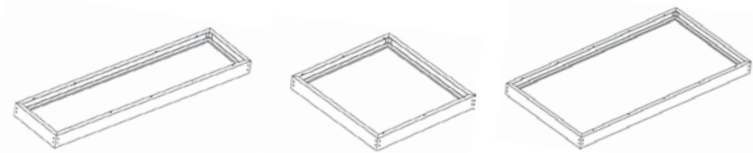

Product #	Product Code	Description
81985	14EPL/SMK	1' X 4' Surface Mount Kit For Led Panels, White (48.12" X 12.06" X 4.5")
81986	22EPL/SMK	2' X 2' Surface Mount Kit For Led Panels, White (24.06" X 24.06" X 4.5")
81987	24EPL/SMK	2' X 4' Surface Mount Kit For Led Panels, White (48.12" X 24.06" X 4.5")



SPEC SHEET AVAILABLE HERE.

ProLED Select Backlit Panel



Product #	Product Code	Wattage	Voltage	Color Temp.	CRI	Lumens	Useful Life ¹	Dimmable	DLC Qualified
90363	BPL-14-WS-CS-U	20W, 30W, 35W	120-277VAC	3500K, 4000K, 5000K	80	2,548-4,217	50,000	0-10V	Yes
90364	BPL-22-WS-CS-U	20W, 30W, 35W	120-277VAC	3500K, 4000K, 5000K	80	2,454-4,044	50,000	0-10V	Yes
90365	BPL-24-WS-CS-U	30W, 35W, 45W	120-277VAC	3500K, 4000K, 5000K	80	3,864-5,544	50,000	0-10V	Yes

Available Accessories

Product #	Product Code	Description
90366	BPL-14-SMK	ProLED Select Backlit Panel 1x4 Surface Mount Kit
90367	BPL-22-SMK	ProLED Select Backlit Panel 2x2 Surface Mount Kit
90368	BPL-24-SMK	ProLED Select Backlit Panel 2x4 Surface Mount Kit
90369	BPL-14-FMK	ProLED Select Backlit Panel 1x4 Flange Mount Kit
90370	BPL-22-FMK	ProLED Select Backlit Panel 2x2 Flange Mount Kit
90371	BPL-24-FMK	ProLED Select Backlit Panel 2x4 Flange Mount Kit
81981	VPL-EM-LED3	Led Panel Gen 3 Emergency Battery 16W
90372	BPL-EMMB1	ProLED Select Backlit Panel 1x4 Emergency Battery Back Up Mounting Bridge Size 1
90373	BPL-EMMB2	ProLED Select Backlit Panel 1x4 Emergency Battery Back Up Mounting Bridge Size 2

SPEC SHEET AVAILABLE HERE.

ProLED Select Volumetric Panel Series



Product #	Product Code	Wattage	Voltage	Color Temp.	CRI	Lumens	Useful Life ¹	Dimmable ²	Eq. Wattage	DLC Qualified ³
1' x 4'										
81779	14FSVPL/8DU	15W, 19W, 24W, 29W	120-277V	3500K, 4000K, 5000K	80	2,190-4,437	50,000	0-10V	(2) 32W T8	Yes
2' x 2'										
81780	22FSVPL/8DU	15W, 19W, 24W, 29W	120-277V	3500K, 4000K, 5000K	80	2,175-4,379	50,000	0-10V	(2) 32W T8	Yes
2' x 4'										
81781	24FSVPL/8DU	24W, 29W, 32W, 39W	120-277V	3500K, 4000K, 5000K	80	3,384-5,889	50,000	0-10V	(4) 32W T8	Yes

Available Accessories

Product #	Product Code	Description
81782	14VPL/SMK	1x4 Surface Mount Kit For Volumetric Panels
81783	22VPL/SMK	2x2 Surface Mount Kit For Volumetric Panels
81784	24VPL/SMK	2x4 Surface Mount Kit For Volumetric Panels
10310	BBU/EM8WU	Emergency Battery Backup 8W 120-277V



[SPEC SHEET AVAILABLE HERE.](#)

ProLED Select Commercial Downlight Series



Product #	Product Code	Wattage	Voltage	Color Temp.	CRI	Lumens	Useful Life ¹	Dimmable	ENERGY STAR [®]
88984	CDL4-WS-CS-U	7W, 10W, 13W	120-277VAC	2700K, 3000K, 3500K, 4000K, 5000K	90	591-1,170	50,000	Yes	Yes
88985	CDL6-WS-CS-U	10W, 15W, 22W	120-277VAC	2700K, 3000K, 3500K, 4000K, 5000K	90	822-1853	50,000	Yes	Yes
88986	CDL8-WS-CS-U	12W, 20W, 30W	120-277VAC	2700K, 3000K, 3500K, 4000K, 5000K	90	1,084-2,640	50,000	Yes	Yes
88987	CDL10-WS-CS-U	20W, 30W, 40W	120-277VAC	2700K, 3000K, 3500K, 4000K, 5000K	90	1,743-3,157	50,000	Yes	Yes

Available Accessories

[SPEC SHEET AVAILABLE HERE.](#)

Product #	Product Code	Description
90313	BBU/EM9WU	Battery Backup Emergency 9W 120-277V 90 Minute 0-10V Dimming
89142	ACC-NCP-ABH-4R	4" Round NC Pan with Adjustable Bar Hangers
89143	ACC-NCP-ABH-6R	6" Round NC Pan with Adjustable Bar Hangers

● Indicates new products added

[SPEC SHEET AVAILABLE HERE.](#)

ProLED Commercial Downlight Retrofit



Product #	Product Code	Wattage	Voltage	Color Temp.	CRI	Lumens	Useful Life ¹	Dimmable ²	Pkg. Qty.	Fixture Size	Eq. Wattage	ENERGY STAR [®]
4" Commercial Downlight Retrofit												
*99610	CDL4FR10/927/RTJB/LED	10W	120-277V	2700K	90	700	50,000	120V Only	1/12	4"	65W	Yes
*99611	CDL4FR10/930/RTJB/LED	10W	120-277V	3000K	90	700	50,000	120V Only	1/12	4"	65W	Yes
*99612	CDL4FR10/940/RTJB/LED	10W	120-277V	4000K	90	700	50,000	120V Only	1/12	4"	65W	Yes
*99613	CDL4FR10/950/RTJB/LED	10W	120-277V	5000K	90	700	50,000	120V Only	1/12	4"	65W	Yes
6" Commercial Downlight Retrofit												
99614	CDL6FR15/927/RTJB/LED	15W	120-277V	2700K	90	1,000	50,000	120V Only	1/12	6"	120W	Yes
99615	CDL6FR15/930/RTJB/LED	15W	120-277V	3000K	90	1,000	50,000	120V Only	1/12	6"	120W	Yes
99616	CDL6FR15/940/RTJB/LED	15W	120-277V	4000K	90	1,000	50,000	120V Only	1/12	6"	120W	Yes
99617	CDL6FR15/950/RTJB/LED	15W	120-277V	5000K	90	1,000	50,000	120V Only	1/12	6"	120W	Yes
8" Commercial Downlight Retrofit												
99618	CDL8FR30/927/RTJB/LED	30W	120-277V	2700K	90	2,000	50,000	120V Only	1/6	8"	200W	Yes
99619	CDL8FR30/930/RTJB/LED	30W	120-277V	3000K	90	2,000	50,000	120V Only	1/6	8"	200W	Yes
99620	CDL8FR30/940/RTJB/LED	30W	120-277V	4000K	90	2,000	50,000	120V Only	1/6	8"	200W	Yes
99621	CDL8FR30/950/RTJB/LED	30W	120-277V	5000K	90	2,000	50,000	120V Only	1/6	8"	200W	Yes

* Phasing out-while supplies last

[SPEC SHEET AVAILABLE HERE.](#)

ProLED Downlight Retrofit Series



Product #	Product Code	Wattage	Voltage	Color Temp.	CRI	Lumens	Useful Life ¹	Eq. Wattage	Dimmable	ENERGY STAR [®]
99733	DL4FR9/927/LED3	9W	120V	2700K	90	765	50,000	65W	Yes	Yes
99734	DL4FR9/930/LED3	9W	120V	3000K	90	765	50,000	65W	Yes	Yes
99735	DL4FR9/940/LED3	9W	120V	4000K	90	765	50,000	65W	Yes	Yes
99736	DL4FR9/950/LED3	9W	120V	5000K	90	765	50,000	65W	Yes	Yes
99741	DL6FR9/927/LED3	9W	120V	2700K	90	810	50,000	75W	Yes	Yes
99742	DL6FR9/930/LED3	9W	120V	3000K	90	810	50,000	75W	Yes	Yes

Continue to next page for additional product information



ProLED Downlight Retrofit Series

Product #	Product Code	Wattage	Voltage	Color Temp.	CRI	Lumens	Useful Life ¹	Eq. Wattage	Dimmable	ENERGY STAR®
99743	DL6FR9/940/LED3	9W	120V	4000K	90	810	50,000	75W	Yes	Yes
99744	DL6FR9/950/LED3	9W	120V	5000K	90	810	50,000	75W	Yes	Yes
99745	DL6FR12/927/LED3	12.5W	120V	2700K	90	1100	50,000	100W	Yes	Yes
99746	DL6FR12/930/LED3	12.5W	120V	3000K	90	1100	50,000	100W	Yes	Yes
99747	DL6FR12/940/LED3	12.5W	120V	4000K	90	1100	50,000	100W	Yes	Yes
99748	DL6FR12/950/LED3	12.5W	120V	5000K	90	1100	50,000	100W	Yes	Yes

SPEC SHEET AVAILABLE HERE.

ProLED Select Retrofit Downlight Series



Product #	Product Code	Wattage	Voltage	Color Temp.	CRI	Lumens	Useful Life ¹	Dimmable	ENERGY STAR®
87983	RDL4-8-CS-BT	8W	120V	2700K, 3000K, 3500K, 4000K, 5000K	92+	707lm - 791lm	50,000	Yes	Yes
87984	RDL6-10.5-CS-BT	10.5W	120V	2700K, 3000K, 3500K, 4000K, 5000K	92+	926lm - 1078lm	50,000	Yes	Yes
87985	RDL6-14-CS-BT	14W	120V	2700K, 3000K, 3500K, 4000K, 5000K	92+	1219lm - 1318lm	50,000	Yes	Yes
87986	RDL4-8-CS-ST	8W	120V	2700K, 3000K, 3500K, 4000K, 5000K	92+	757lm - 849lm	50,000	Yes	Yes
87987	RDL6-10.5-CS-ST	10.5W	120V	2700K, 3000K, 3500K, 4000K, 5000K	92+	965lm - 1084lm	50,000	Yes	Yes
87988	RDL6-14-CS-ST	14W	120V	2700K, 3000K, 3500K, 4000K, 5000K	92+	1276lm - 1380lm	50,000	Yes	Yes

Available Accessories

Product #	Product Code	Description
87960	RDL4-RT-BT-BK	ProLED Select Retrofit Downlight 4" Round Replaceable Baffle Trim Black
87961	RDL6-RT-BT-BK	ProLED Select Retrofit Downlight 6" Round Replaceable Baffle Trim Black
87962	RDL4-RT-ST-BK	ProLED Select Retrofit Downlight 4" Round Replaceable Smooth Trim Black
87963	RDL6-RT-ST-BK	ProLED Select Retrofit Downlight 6" Round Replaceable Smooth Trim Black
87964	RDL4-RT-BT-BN	ProLED Select Retrofit Downlight 4" Round Replaceable Baffle Trim Brushed Nickel
87965	RDL6-RT-BT-BN	ProLED Select Retrofit Downlight 6" Round Replaceable Baffle Trim Brushed Nickel
87966	RDL4-RT-ST-BN	ProLED Select Retrofit Downlight 4" Round Replaceable Smooth Trim Brushed Nickel
87967	RDL6-RT-ST-BN	ProLED Select Retrofit Downlight 6" Round Replaceable Smooth Trim Brushed Nickel
87968	RDL4-RT-BT-BZ	ProLED Select Retrofit Downlight 4" Round Replaceable Baffle Trim Bronze
87969	RDL6-RT-BT-BZ	ProLED Select Retrofit Downlight 6" Round Replaceable Baffle Trim Bronze
87970	RDL4-RT-ST-BZ	ProLED Select Retrofit Downlight 4" Round Replaceable Smooth Trim Bronze
87971	RDL6-RT-ST-BZ	ProLED Select Retrofit Downlight 6" Round Replaceable Smooth Trim Bronze
87972	RDL6-RB	ProLED Select Retrofit Downlight 6" Friction Installation Band
87973	RDL4-GR	ProLED Select Retrofit Downlight 4" Goof Ring 4"-6"
87974	RDL6-GR	ProLED Select Retrofit Downlight 6" Goof Ring 6"-8"



SPEC SHEET AVAILABLE HERE.

ProLED Select Direct Fit Gimbal Downlight Series



Product #	Product Code	Wattage	Voltage	Color Temp.	Lumens	Useful Life ¹	Dimmable ²	Eq. Wattage	ENERGY STAR [®]
82115	DFDLG3-8-CS	8W	120VAC	2700K, 3000K, 3500K, 4000K, 5000K	510-597	50,000	Yes	50W	Yes
82116	DFDLG4-12-CS	12W	120VAC	2700K, 3000K, 3500K, 4000K, 5000K	920-1,087	50,000	Yes	100W	Yes

Available Accessories

Product #	Product Code	Description
87960	RDL4-RT-BT-BK	ProLED Select Retrofit Downlight 4" Round Replaceable Baffle Trim Black
87961	RDL6-RT-BT-BK	ProLED Select Retrofit Downlight 6" Round Replaceable Baffle Trim Black
87962	RDL4-RT-ST-BK	ProLED Select Retrofit Downlight 4" Round Replaceable Smooth Trim Black

SPEC SHEET AVAILABLE HERE.

ProLED Select Gimbal Downlight Series



Product #	Product Code	Wattage	Voltage	Color Temp.	Lumens	Useful Life ¹	Dimmable ²	Eq. Wattage	ENERGY STAR [®]
83986	FSDLG4FR8/CCT/LED	8W	120VAC	2700K, 3000K, 3500K, 4000K, 5000K	741-815	50,000	Yes	60W	Yes
83987	FSDLG6FR10/CCT/LED	10W	120VAC	2700K, 3000K, 3500K, 4000K, 5000K	969-1,067	50,000	Yes	100W	Yes
83988	FSDLG6FR11/CCT/LED	11W	120VAC	2700K, 3000K, 3500K, 4000K, 5000K	1,126-1,184	50,000	Yes	120W	Yes

SPEC SHEET AVAILABLE HERE.

ProLED Select Surface Downlight Series



Product #	Product Code	Wattage	Voltage	Color Temp.	CRI	Lumens	Useful Life ¹	EQ Wattage	Dimmable	ENERGY STAR [®]
82993	SDL4-10-CS	10W	120VAC	2700K, 3000K, 3500K, 4000K, 5000K	90	650	50,000	85W	Yes	Yes
82994	SDL6-15-CS	15W	120VAC	2700K, 3000K, 3500K, 4000K, 5000K	90	1,050	50,000	85W	Yes	Yes
82995	SDL8-20-CS	20W	120VAC	2700K, 3000K, 3500K, 4000K, 5000K	90	1,500	50,000	85W	Yes	Yes
82996	SDL6-15-CS-MS	15W	120VAC	2700K, 3000K, 3500K, 4000K, 5000K	90	1,050	50,000	85W	Yes	Yes

SPEC SHEET AVAILABLE HERE.

ProLED Surface Downlight Retrofit Series



Product #	Product Code	Wattage	Voltage	Color Temp.	CRI	Lumens	Useful Life ¹	Pkg. Qty.	Fixture Size	EQ Wattage	Dimmable	ENERGY STAR [®]
82989	SDL6FR15/927/LED3	15W	120V	2700K	90	1,200	50,000	1/12	6"	85W	Yes	Yes
82990	SDL6FR15/930/LED3	15W	120V	3000K	90	1,200	50,000	1/12	6"	85W	Yes	Yes
82991	SDL6FR15/940/LED3	15W	120V	4000K	90	1,200	50,000	1/12	6"	85W	Yes	Yes
82992	SDL6FR15/950/LED3	15W	120V	5000K	90	1,200	50,000	1/12	6"	85W	Yes	Yes

SPEC SHEET AVAILABLE HERE.

ProLED Select Slim Downlight Series



Product #	Product Code	Wattage	Voltage	Color Temp.	CRI	Lumens	Useful Life ¹	Dimmable	ENERGY STAR [®]
89152	FSDLS3FR8/CCT/LED	8W	120VAC	2700K, 3000K, 3500K, 4000K, 5000K	90	546-569	50,000	Yes	Yes
89093	FSDLS4FR10/CCT/LED	10W	120V	2700K, 3000K, 3500K, 4000K, 5000K	90+	773 - 827	50,000	Yes	Yes
89153	FSDLS5FR12/CCT/LED	12W	120VAC	2700K, 3000K, 3500K, 4000K, 5000K	90	830-981	50,000	Yes	Yes
89094	FSDLS6FR12/CCT/LED	12W	120V	2700K, 3000K, 3500K, 4000K, 5000K	90+	954 - 1,024	50,000	Yes	Yes
89095	FSDLS6FR15/CCT/LED	15W	120V	2700K, 3000K, 3500K, 4000K, 5000K	90+	1,116 - 1,242	50,000	Yes	Yes

Continue to next page for additional product information



ProLED Select Slim Downlight Series

Product #	Product Code	Wattage	Voltage	Color Temp.	CRI	Lumens	Useful Life ¹	Dimmable	ENERGY STAR®
89106	FSDLS8FR18/CCT/LED	18W	120V	2700K, 3000K, 3500K, 4000K, 5000K	90+	1,506 - 1,607	50,000	Yes	Yes
89096	FSDLS4FR10/SQ/CCT/LED	10W	120V	2700K, 3000K, 3500K, 4000K, 5000K	90+	686 - 740	50,000	Yes	Yes
89097	FSDLS6FR12/SQ/CCT/LED	12W	120V	2700K, 3000K, 3500K, 4000K, 5000K	90+	1,036 - 1,107	50,000	Yes	Yes
89098	FSDLS6FR15/SQ/CCT/LED	15W	120V	2700K, 3000K, 3500K, 4000K, 5000K	90+	1,130 - 1,235	50,000	Yes	Yes

Available Accessories

Product #	Product Code	Description
89120	DFDLS4-RT-RD-BK	ProLED Select Direct Fit Slim Downlight 4" Round Replaceable Trim Black
89121	DFDLS6-RT-RD-BK	ProLED Select Direct Fit Slim Downlight 6" Round Replaceable Trim Black
89122	DFDLS8-RT-RD-BK	ProLED Select Direct Fit Slim Downlight 8" Round Replaceable Trim Black
89123	DFDLS4-RT-RD-SN	ProLED Select Direct Fit Slim Downlight 4" Round Replaceable Trim Satin Nickel
89124	DFDLS6-RT-RD-SN	ProLED Select Direct Fit Slim Downlight 6" Round Replaceable Trim Satin Nickel
89125	DFDLS8-RT-RD-SN	ProLED Select Direct Fit Slim Downlight 8" Round Replaceable Trim Satin Nickel
89126	DFDLS4-RT-RD-BZ	ProLED Select Direct Fit Slim Downlight 4" Round Replaceable Trim Bronze
89127	DFDLS6-RT-RD-BZ	ProLED Select Direct Fit Slim Downlight 6" Round Replaceable Trim Bronze
89128	DFDLS8-RT-RD-BZ	ProLED Select Direct Fit Slim Downlight 8" Round Replaceable Trim Bronze
89102	FSDLS/EXT12	ProLED Select Direct Fit Slim Downlight Extension Cable 12"
89104	DLS/RP4RD	ProLED Direct Fit Slim Downlight Rough In Pan 4" Round
89088	DLS/FK4SQ	Slim Downlight New Construction Frame - 4" Square
89105	DLS/RP6RD	ProLED Direct Fit Slim Downlight Rough In Pan 6" Round
89090	DLS/FK6SQ	Slim Downlight New Construction Frame - 6" Square
89129	DFDLS-RP-468-RD	ProLED Select Direct Fit Slim Downlight Adjustable Rough In Pan 4" 6" 8" Round

SPEC SHEET AVAILABLE HERE.

ProLED Select Slim Downlight Series 4-Pack



Product #	Product Code	Wattage	Voltage	Color Temp.	CRI	Lumens	Useful Life ¹	Dimmable	ENERGY STAR®
89140	FSDLS4FR10/CCT/LED/4PK	10W	120VAC	2700K, 3000K, 3500K, 4000K, 5000K	90	773-827	50,000	Yes	Yes
89141	FSDLS6FR12/CCT/LED/4PK	12W	120VAC	2700K, 3000K, 3500K, 4000K, 5000K	90	954-1024	50,000	Yes	Yes

SPEC SHEET AVAILABLE HERE.

ProLED Select Direct Fit Downlight Series



Product #	Product Code	Wattage	Voltage	Color Temp.	CRI	Lumens	Useful Life ¹	Dimmable	ENERGY STAR®
89150	DFDLS3-8-CS-BT	8W	120VAC	2700K, 3000K, 3500K, 4000K, 5000K	90	484-529	50,000	Yes	Yes
89107	DFDLS4-10-CS-BT	10W	120V	2700K, 3000K, 3500K, 4000K, 5000K	90+	725 - 728	50,000	Yes	Yes
89151	DFDLS5-12-CS-BT	12W	120VAC	2700K, 3000K, 3500K, 4000K, 5000K	90	817-975	50,000	Yes	Yes
89108	DFDLS6-12-CS-BT	12W	120V	2700K, 3000K, 3500K, 4000K, 5000K	90+	918 - 1,020	50,000	Yes	Yes
89109	DFDLS6-15-CS-BT	15W	120V	2700K, 3000K, 3500K, 4000K, 5000K	90+	1,122 - 1,314	50,000	Yes	Yes
89110	DFDLS8-18-CS-BT	18W	120V	2700K, 3000K, 3500K, 4000K, 5000K	90+	1,619 - 1,741	50,000	Yes	Yes



Available Accessories

Product #	Product Code	Description
89156	DFDLS3-RT-RD-BT-BK	ProLED Select Direct Fit Slim Downlight 3" Round Replaceable Baffle Trim Black
89111	DFDLS4-RT-RD-RC-BK	ProLED Select Direct Fit Slim Downlight 4" Round Replaceable Recessed Trim Black
89157	DFDLS5-RT-RD-BT-BK	ProLED Select Direct Fit Slim Downlight 5" Round Replaceable Baffle Trim Black
89112	DFDLS6-RT-RD-RC-BK	ProLED Select Direct Fit Slim Downlight 6" Round Replaceable Recessed Trim Black
89113	DFDLS8-RT-RD-RC-BK	ProLED Select Direct Fit Slim Downlight 8" Round Replaceable Recessed Trim Black
89160	DFDLS3-RT-RD-BT-SN	ProLED Select Direct Fit Slim Downlight 3" Round Replaceable Baffle Trim Satin Nickel
89114	DFDLS4-RT-RD-RC-SN	ProLED Select Direct Fit Slim Downlight 4" Round Replaceable Recessed Trim Satin Nickel
89161	DFDLS5-RT-RD-BT-SN	ProLED Select Direct Fit Slim Downlight 5" Round Replaceable Baffle Trim Satin Nickel
89115	DFDLS6-RT-RD-RC-SN	ProLED Select Direct Fit Slim Downlight 6" Round Replaceable Recessed Trim Satin Nickel
89116	DFDLS8-RT-RD-RC-SN	ProLED Select Direct Fit Slim Downlight 8" Round Replaceable Recessed Trim Satin Nickel
89164	DFDLS3-RT-RD-BT-BZ	ProLED Select Direct Fit Slim Downlight 3" Round Replaceable Baffle Trim Bronze
89117	DFDLS4-RT-RD-RC-BZ	ProLED Select Direct Fit Slim Downlight 4" Round Replaceable Recessed Trim Bronze
89165	DFDLS5-RT-RD-BT-BZ	ProLED Select Direct Fit Slim Downlight 5" Round Replaceable Baffle Trim Bronze
89118	DFDLS6-RT-RD-RC-BZ	ProLED Select Direct Fit Slim Downlight 6" Round Replaceable Recessed Trim Bronze
89119	DFDLS8-RT-RD-RC-BZ	ProLED Select Direct Fit Slim Downlight 8" Round Replaceable Recessed Trim Bronze
89129	DFDLS-RP-468-RD	ProLED Select Direct Fit Slim Downlight Adjustable Rough In Pan 4", 6", 8"
89166	FSDLS/RP3RD	ProLED Select Direct Fit Slim Downlight Rough In Pan 3"
89104	FSDLS/RP4RD	ProLED Select Direct Fit Slim Downlight Rough In Pan 4"
89167	FSDLS/RP5RD	ProLED Select Direct Fit Slim Downlight Rough In Pan 5"
89105	FSDLS/RP6RD	ProLED Select Direct Fit Slim Downlight Rough In Pan 6"
89102	FSDLS/EXT12	ProLED Select Direct Fit Slim Downlight Extension Cable 12"

SPEC SHEET AVAILABLE HERE.

ProLED Square Downlights



Product #	Product Code	Wattage	Voltage	Color Temp.	CRI	Lumens	Useful Life ¹	Dimmable ²	Pkg. Qty.	Fixture Size	Eq. Wattage	ENERGY STAR [®]
99952	QDL4FR10/927/LED	10W	120V	2700K	90	560	50,000	Yes	1/12	4"	50W	Yes

SPEC SHEET AVAILABLE HERE.

ProLED Select Flushmount Fixtures



Product #	Product Code	Wattage	Voltage	Color Temp.	CRI	Lumens	Useful Life ¹	Dimmable ²	ENERGY STAR [®]
90260	FM-DR12-16-CS	16W	120VAC	2700K, 3000K, 3500K, 4000K, 5000K	80	1,193 - 1,316	50,000	Yes	Yes
90261	FM-DR14-20-CS	20W	120VAC	2700K, 3000K, 3500K, 4000K, 5000K	80	1,498 - 1,741	50,000	Yes	Yes
90262	FM-DR16-24-CS	24W	120VAC	2700K, 3000K, 3500K, 4000K, 5000K	80	1,607 - 1,905	50,000	Yes	Yes
90263	FM-M11-16-CS	16W	120VAC	2700K, 3000K, 3500K, 4000K, 5000K	80	1,312 - 1,465	50,000	Yes	Yes
90264	FM-M14-24-CS	24W	120VAC	2700K, 3000K, 3500K, 4000K, 5000K	80	1,489 - 1,780	50,000	Yes	Yes

LED LAMPS

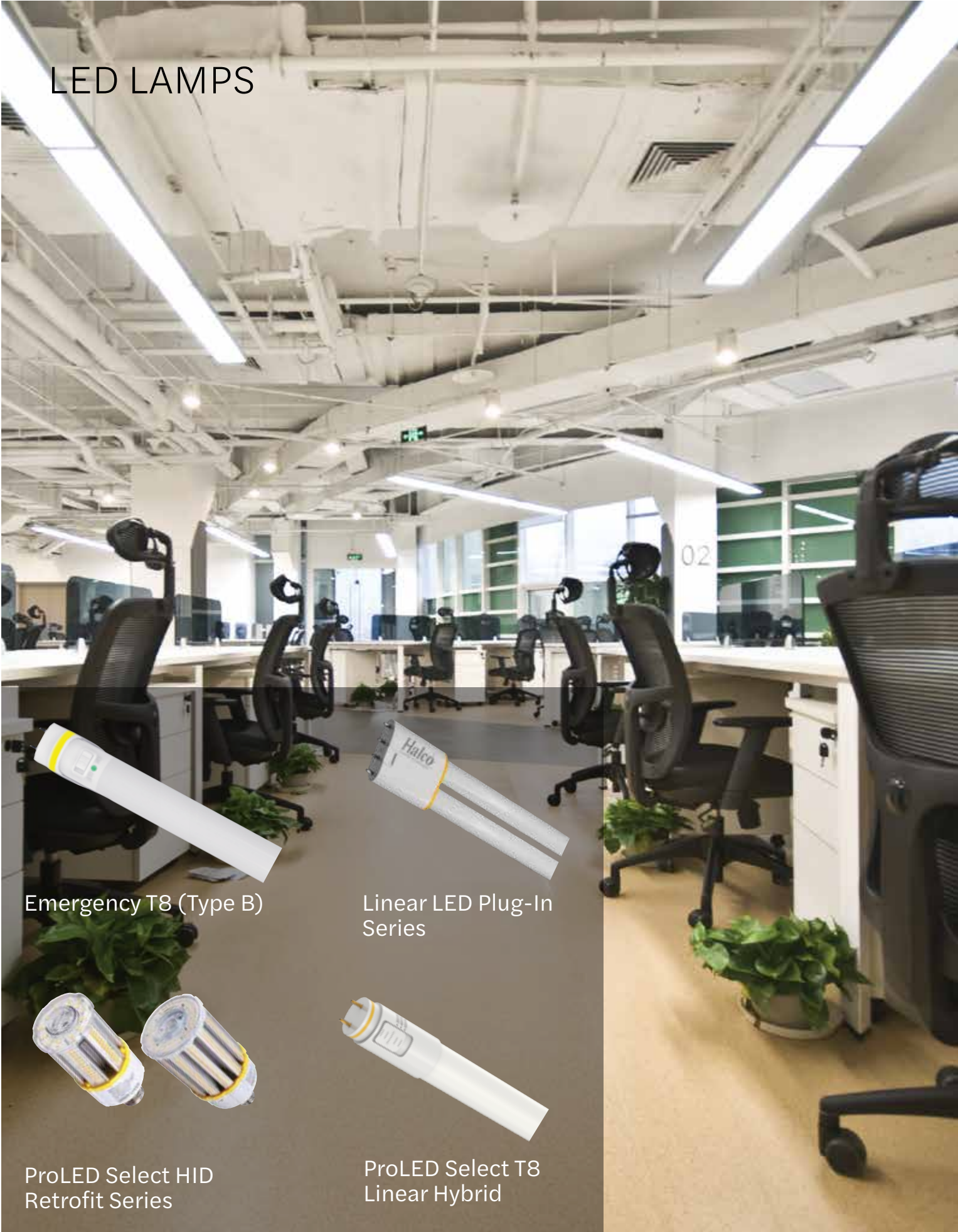

Emergency T8 (Type B)



Linear LED Plug-In Series



ProLED Select HID Retrofit Series



ProLED Select T8 Linear Hybrid

SPEC SHEET AVAILABLE HERE.

ProLED HID Highbay Replacement Lamp



Product #	Product Code	Wattage	Base	Voltage	Color Temp.	CRI	Lumens	Useful Life	MOL	DLC Qualified
89091	HRSL-1-WS-CS-U-EX39	70W-80W-90W	EX39	120-277VAC	3000K, 4000K, 5000K Selectable	>80	10,683 - 14,130	>50,000 Hrs	9.33"	Premium
89092	HRSL-2-WS-CS-U-EX39	100W-120W-140W	EX39	120-277VAC	3000K, 4000K, 5000K Selectable	>80	14,800 - 22,120	>50,000 Hrs	10.35"	Premium

SPEC SHEET AVAILABLE HERE.

ProLED HID Wallpack Retrofit Series



Product #	Product Code	Wattage	Base	Voltage	Color Temp.	CRI	Lumens	Useful Life ¹	Dimmable ²	Pkg. Qty.	MOL	Eq. Wattage	DLC Qualified ³
84027	HID40/840/MV/EX39/LED	40W	EX39	120-277V	4000K	82	6,000	50,000	No	1/8	8.46"	175W MH/HPS	Yes

SPEC SHEET AVAILABLE HERE.

ProLED HID Omni Retrofit Series



Product #	Product Code	Wattage	Base	Voltage	Color Temp.	CRI	Lumens	Useful Life ¹	Dimmable ²	Pkg. Qty.	MOL	Eq. Wattage	DLC Qualified ³
84318	HID20/OMNI/830/LED	20W	E26	120-277V	3000K	84	2,780	50,000	No	1/24	5.26"	80W MH/HPS	No
84319	HID20/OMNI/850/LED	20W	E26	120-277V	5000K	84	2,865	50,000	No	1/24	5.26"	80W MH/HPS	No
84320	HID25/OMNI/830/LED	25W	E26	120-277V	3000K	84	3,500	50,000	No	1/24	6.28"	100W MH/HPS	No
84321	HID25/OMNI/850/LED	25W	E26	120-277V	5000K	84	3,612	50,000	No	1/24	6.28"	100W MH/HPS	No
84322	HID25/OMNI/830/EX39/LED	25W	EX39	120-277V	3000K	84	3,500	50,000	No	1/24	6.28"	100W MH/HPS	Yes
84323	HID25/OMNI/850/EX39/LED	25W	EX39	120-277V	5000K	84	3,612	50,000	No	1/24	6.28"	100W MH/HPS	Yes
84324	HID35/OMNI/830/EX39/LED	35W	EX39	120-277V	3000K	84	4,620	50,000	No	1/12	7.25"	150W MH/HPS	Yes
84325	HID35/OMNI/850/EX39/LED	35W	EX39	120-277V	5000K	84	4,760	50,000	No	1/12	7.25"	150W MH/HPS	Yes

SPEC SHEET AVAILABLE HERE.

ProLED Select HID Retrofit Series



Product #	Product Code	Wattage	Voltage	Color Temp.	Lumens	Useful Life ¹	Dimmable ²	Eq. Wattage	DLC Qualified	ENERGY STAR [®]
82361	HID12-CS-E26-LED	12W	100-277V	3000, 4000, 5000K	1,680-1,800	50,000	No	50W	Yes	No
82362	HID18-CS-E26-LED	18W	100-277V	3000, 4000, 5000K	2,520-2,700	50,000	No	70W	Yes	No
82363	HID36-CS-E26-LED	36W	100-277V	3000, 4000, 5000K	2,520-5,652	50,000	No	150W	Yes	No
82364	HID36-CS-EX39-LED	36W	100-277V	3000, 4000, 5000K	2,520-5,652	50,000	No	150W	Yes	No
82365	HID45-CS-E26-LED	45W	100-277V	3000, 4000, 5000K	3,780-7,065	50,000	No	150W	Yes	No
82366	HID45-CS-EX39-LED	45W	100-277V	3000, 4000, 5000K	3,780-7,065	50,000	No	150W	Yes	No
82367	HID54-CS-E26-LED	54W	100-277V	3000, 4000, 5000K	5,040-8,478	50,000	No	175W	Yes	No
82368	HID54-CS-EX39-LED	54W	100-277V	3000, 4000, 5000K	5,040-8,478	50,000	No	175W	Yes	No
82369	HID80-CS-EX39-LED	80W	100-277V	3000, 4000, 5000K	7,560-12,560	50,000	No	250W	Yes	No
82370	HID100-CS-EX39-LED	100W	100-277V	3000, 4000, 5000K	8,820-15,700	50,000	No	250W	Yes	No
82371	HID120-CS-EX39-LED	120W	100-277V	3000, 4000, 5000K	11,200-18,840	50,000	No	400W	Yes	No



SPEC SHEET AVAILABLE HERE.

ProLED Temporary Work Light



Product #	Product Code	Wattage	Voltage	Color Temp	CRI	Lumens	Useful Life	Beam Angle
82378	WKL60-850-LED	60W	120-277V	5000K	80	7,200	50,000	360
82379	WKL100-850-LED	100W	120-277V	5000K	80	12,000	50,000	360
82380	WKL150-850-LED	150W	120-277V	5000K	80	18,000	50,000	360

Available Accessories

Product #	Product Code	Description
82381	WKL-Tripod	Led Temporary Work Light Tripod Stand Accessory

SPEC SHEET AVAILABLE HERE.

LED T8 Type B 96in (2x48") 42W Color Selectable



Product #	Product Code	Wattage	Voltage	Color Temp	CRI	Lumens	Useful Life	Beam Angle
87210	96T8VC-42-8CS-DE-BYP-LED-CG	42W	120-277V	3000, 3500, 4000, 5000, 6500K	80	4620-5000	50,000	160

Accessories

FA8 and R17D End Caps Included

SPEC SHEET AVAILABLE HERE.

ProLED Linear T8 Series (Type A)



Product #	Product Code	Description	Watt	System Watt	Base	Voltage	CCT	CRI	Lumens	Useful Life	Pkg. Qty.	MOL	Eq. Wattage	End Cap	
2 Foot															
82355	T824FR8/835/DIR3/LED	QuickConnect Type A LED T8 Linear 24 3500K	8W	11W	G13	120-277V	3500K	82	1,325	50,000	1/25	24"	17W	Metal	
82356	T824FR8/840/DIR3/LED	QuickConnect Type A LED T8 Linear 24 4000K	8W	11W	G13	120-277V	4000K	82	1,350	50,000	1/25	24"	17W	Metal	
82357	T824FR8/850/DIR3/LED	QuickConnect Type A LED T8 Linear 24 5000K	8W	11W	G13	120-277V	5000K	82	1,350	50,000	1/25	24"	17W	Metal	
3 Foot															
82358	T836FR11/835/DIR3/LED	QuickConnect Type A LED T8 Linear 36 3500K	11W	14W	G13	120-277V	3500K	82	1,675	50,000	1/25	36"	25W	Metal	
82359	T836FR11/840/DIR3/LED	QuickConnect Type A LED T8 Linear 36 4000K	11W	14W	G13	120-277V	4000K	82	1,700	50,000	1/25	36"	25W	Metal	
82360	T836FR11/850/DIR3/LED	QuickConnect Type A LED T8 Linear 36 5000K	11W	14W	G13	120-277V	5000K	82	1,700	50,000	1/25	36"	25W	Metal	
4 Foot															
83881	T8FR12/840/DIR4/LED	LED T8 12W 4000K Ballast Compatible Direct Fit Dimmable 48 ProLED	12W	14W	G13	120-277V	4000K	82	1,900	50,000	1/25	48"	32W	Metal	

Must be operated with an ambient luminaire temperature between 32°F(0°C) and 113°F(45°C). Warning Halco ProLED® Linear Bypass T8 will not operate on a linear fluorescent ballast or with shunted lamp holders. Please re-wire the luminaire as shown in the installation instructions included with the product and ensure non-shunted lamp holders are installed in the luminaire before installing this product.

SPEC SHEET AVAILABLE HERE.

ProLED T8 8Ft Linear Double Ended Bypass Series



Product #	Product Code	Lamp Wattage	Base	Voltage	Color Temp.	CRI	Lumens	Useful Life ²	Dimmable ³	Pkg. Qty.	Beam Spread	MOL	THD	Eq. Wattage	DLC Qualified ⁴
82875	T896FR42/840/BYP2/SP/LED	42W	Fa8	120-277V	4000K	82	5,500	50,000	No	10	270°	96"	<20%	86W	Yes
82876	T896FR42/850/BYP2/SP/LED	42W	Fa8	120-277V	5000K	82	5,500	50,000	No	10	270°	96"	<20%	86W	Yes
82877	T896FR42/840/BYP2/RDC/LED	42W	R17d	120-277V	4000K	82	5,500	50,000	No	10	270°	96"	<20%	86W	Yes
82878	T896FR42/850/BYP2/RDC/LED	42W	R17d	120-277V	5000K	82	5,500	50,000	No	10	270°	96"	<20%	86W	Yes
82879	T896FR42/865/BYP2/RDC/LED	42W	R17d	120-277V	6500K	82	5500	50,000	No	10	270°	96"	<20%	86W	Yes

SPEC SHEET AVAILABLE HERE.

ProLED T8 Linear Double Ended Bypass Series (Type B)



Product #	Product Code	Wattage	Base	Voltage	Color Temp.	CRI	Lumens	Useful Life ²	Dimmable ³	Pkg. Qty.	Beam Spread	MOL	THD	Eq. Wattage	DLC Qualified ⁴
83886	T8FR12/835/BYP3/DE/LED	12W	G13	120-277V	3500K	82	1,700	50,000	No	1/25	270°	48"	<20%	32W	Yes

Must be operated with an ambient luminaire temperature between 32°F (0°C) and 113°F (45°C). Warning Halco ProLED® Linear Bypass T8 will not operate on a linear fluorescent ballast or with shunted lamp holders. Please re-wire the luminaire as shown in the installation instructions included with the product and ensure non-shunted lamp holders are installed in the luminaire before installing this product.

SPEC SHEET AVAILABLE HERE.

ProLED T8 Linear Double, Single Ended Bypass Series (Type B)



Product #	Product Code	Wattage	Base	Voltage	CCT	CRI	Lumens	Useful Life	Beam Spread	Pkg. Qty.	MOL	Coated	Eq. Wattage
*84886	T848FR12/835/BYP4/DSE/LED	12.5W	G13	120-277V	3500K	83	1,700	50,000	160°	25	48"	No	32W
*84887	T848FR12/840/BYP4/DSE/LED	12.5W	G13	120-277V	4000K	83	1,800	50,000	160°	25	48"	No	32W
84875	T836FR12/835/BYP4/DSE/LED	12W	G13	120-277V	3500K	83	1,450	50,000	160°	25	36"	No	25W
84876	T836FR12/840/BYP4/DSE/LED	12W	G13	120-277V	4000K	83	1,500	50,000	160°	25	36"	No	25W
84877	T836FR12/850/BYP4/DSE/LED	12W	G13	120-277V	5000K	83	1,550	50,000	160°	25	36"	No	25W
84878	T836FR12/865/BYP4/DSE/LED	12W	G13	120-277V	6500K	83	1,450	50,000	160°	25	36"	No	25W
84871	T824FR7/835/BYP4/DSE/LED	7W	G13	120-277V	3500K	83	900	50,000	160°	25	24"	No	17W
84872	T824FR7/840/BYP4/DSE/LED	7W	G13	120-277V	4000K	83	950	50,000	160°	25	24"	No	17W
84873	T824FR7/850/BYP4/DSE/LED	7W	G13	120-277V	5000K	83	1,000	50,000	160°	25	24"	No	17W
84874	T824FR7/865/BYP4/DSE/LED	7W	G13	120-277V	6500K	83	900	50,000	160°	25	24"	No	17W

PET Coated

87200	48T8HE-10-835-DSE-BYP-LED	10.5W	G13	120-277V	3500K	83	1600	50000	240°	25	48"	Yes	32W
87201	48T8HE-10-840-DSE-BYP-LED	10.5W	G13	120-277V	4000K	83	1680	50000	240°	25	48"	Yes	32W
87202	48T8HE-10-850-DSE-BYP-LED	10.5W	G13	120-277V	5000K	83	1680	50000	240°	25	48"	Yes	32W
87203	48T8HO-15-835-DSE-BYP-LED-CG	15W	G13	120-277V	3500K	83	2150	50000	240°	25	48"	Yes	32W
87204	48T8HO-15-840-DSE-BYP-LED-CG	15W	G13	120-277V	4000K	83	2200	50000	240°	25	48"	Yes	32W
87205	48T8HO-15-850-DSE-BYP-LED-CG	15W	G13	120-277V	5000K	83	2200	50000	240°	25	48"	Yes	32W
87206	48T8-14-835-DSE-BYP-LED-CG	14W	G13	120-277V	3500K	82	1700	50000	240°	25	48"	Yes	32W
87207	48T8-14-840-DSE-BYP-LED-CG	14W	G13	120-277V	4000K	82	1800	50000	240°	25	48"	Yes	32W
87208	48T8-14-850-DSE-BYP-LED-CG	14W	G13	120-277V	5000K	82	1800	50000	240°	25	48"	Yes	32W
87209	48T8-14-865-DSE-BYP-LED-CG	14W	G13	120-277V	6500K	82	1800	50000	240°	25	48"	Yes	32W

● Indicates new products added

* Phasing out-while supplies last

SPEC SHEET AVAILABLE HERE.

Emergency T8 (Type B)



Product #	Product Code	Watts	Base Type	Voltage	Color Temp.	CRI	Lumens	Emergency Power Lumen Output	Useful Life	Dimmable	Pkg Qty	Beam Spread	MOL
82373	T8EM-48FR17-40BYP-LED-2PK	17W	G13	120-277	4000K	80+	2,100	400	50000	Yes @ 120V	2/12	160°	48"
82374	T8EM-48FR17-50BYP-LED-2PK	17W	G13	120-277	5000K	80+	2,100	400	50000	Yes @ 120V	2/12	160°	48"



[SPEC SHEET AVAILABLE HERE.](#)

ProLED Linear T8 Hybrid (Type A/B)



Product #	Product Code	Type A Watt.	Type B Watt.	Base Type	Voltage	Color Temp.	CRI	Lumens	Useful Life ¹	Dimmable ²	Pkg Qty	Beam Spread	MOL	THD	Eq. Watt.	DLC Qualified ³
**87000	48T8-12-835-HYB-D-LED2	Based on ballast	12W	G13	120-277V	3500K	83	1,700	50,000	Yes*	1/25	320°	48"	<20	32W	Yes
**87001	48T8-12-840-HYB-D-LED2	Based on ballast	12W	G13	120-277V	4000K	83	1,800	50,000	Yes*	1/25	320°	48"	<20	32W	Yes
87002	48T8-12-850-HYB-D-LED2	Based on ballast	12W	G13	120-277V	5000K	83	1,800	50,000	Yes*	1/25	320°	48"	<20	32W	Yes

*Dimming is dependent on the ballast in Type A applications, and a separate (not included) dimming module in Type B applications.

** Phasing out-while supplies last

[SPEC SHEET AVAILABLE HERE.](#)

ProLED Select T8 Linear Hybrid (Type A/B)



Product #	Product Code	Type A Watt.	Type B Watt.	Base Type	Voltage	Color Temp.	CRI	Lumens	Useful Life ¹	Dimmable ²	Pkg Qty	Beam Spread	MOL	THD	Eq. Watt.	DLC Qualified ³
87100	24T8-8-8CS-HYB-D-LED	Based on ballast	8W	G13	120-277V	3500K, 4000K, 5000K	83	960	50,000	Yes*	1/25	320°	24"	<20	32W	Yes
87101	36T8-12-8CS-HYB-D-LED	Based on ballast	12W	G13	120-277V	3500K, 4000K, 5000K	83	1,500	50,000	Yes*	1/25	320°	36"	<20	32W	Yes
87102	48T8-12-8CS-HYB-D-LED	Based on ballast	12.5W	G13	120-277V	3500K, 4000K, 5000K	83	1,600	50,000	Yes*	1/25	320°	48"	<20	32W	Yes

*Dimming is dependent on the ballast in Type A applications, and a separate (not included) dimming module in Type B applications.

[SPEC SHEET AVAILABLE HERE.](#)

ProLED T8 U-Bend Hybrid (Type A/B)



Product #	Product Code	Nominal Wattage	Base Type	Voltage	Color Temp.	CRI	Lumens	Useful Life ¹	Dimmable ²	Pkg Qty	Beam Angle	MOL	Eq. Watt.	DLC Qualified ³
82375	T8U6-FR13-835-HYB-LED	13W	2G13	120-277V	3500K	83	1,900	50,000	Yes	12	160°	24"	32W	Yes
82376	T8U6-FR13-840-HYB-LED	13W	2G13	120-277V	4000K	83	2,000	50,000	Yes	12	260°	24"	32W	Yes
82377	T8U6-FR13-850-HYB-LED	13W	2G13	120-277V	5000K	83	2,000	50,000	Yes	12	160°	24"	32W	Yes

Must be operated with an ambient luminaire temperature between 32°F(0°C) and 113°F(45°C). Specifications are based on use with normal ballast factor ballasts (0.88). For LBF and HBF ballast performance, see the ProLED® Linear Direct T5 Specifications Sheet.

[SPEC SHEET AVAILABLE HERE.](#)

ProLED T5 Direct Fit Replacement Series (Type A)



Product #	Product Code	Wattage	System Wattage ¹	Base	Voltage	Color Temp.	CRI	Lumens	Useful Life ²	Dimmable ³	Pkg. Qty.	Beam Spread	MOL	THD	Eq. Wattage	DLC Qualified ⁴
84080	T5FR25/840/DIR2/HO/LED	25W	28W	G5	120-277V	4000K	82	3,500	50,000	No	1/25	270°	45.2"	<20%	54W	Yes
84081	T5FR25/850/DIR2/HO/LED	25W	28W	G5	120-277V	5000K	82	3,500	50,000	No	1/25	270°	45.2"	<20%	54W	Yes

Must be operated with an ambient luminaire temperature between 32°F(0°C) and 113°F(45°C). Specifications are based on use with normal ballast factor ballasts (0.88). For LBF and HBF ballast performance, see the ProLED® Linear Direct T5 Specifications Sheet.

[SPEC SHEET AVAILABLE HERE.](#)

ProLED T5 Single End Bypass Series



Product #	Product Code	Wattage	Voltage	Color Temp.	CRI	Lumens	Useful Life ¹	Dimmable ²	Pkg Qty	Beam Spread	MOL	THD	Equivalent Wattage	DLC Qualified ³
82987	T5FR25/840/BYP/HO/LED	25W	120-277V	4000K	80	3,300	50,000	No	1/25	270°	45.2"	<20	54W	Yes
82988	T5FR25/850/BYP/HO/LED	25W	120-277V	5000K	80	3,400	50,000	No	1/26	271°	45.2"	<20	54W	Yes

Must be operated with an ambient luminaire temperature between 32°F(0°C) and 113°F(45°C). Specifications are based on use with normal ballast factor ballasts (0.88). For LBF and HBF ballast performance, see the ProLED® Linear Direct T5 Specifications Sheet.

[SPEC SHEET AVAILABLE HERE.](#)

ProLED A19 ECO Series



Product #	Product Code	Wattage	Base	Voltage	Color Temp	CRI	Lumens	Useful Life	Dimmable	Pkg. Qty.	MOL	Eq. Wattage	New Gen #
88000*	A19FR6-827-ECO-LED4	5.5W	E26	120V	2700K	80	450	15,000	No	1/48	4.13"	40W	85090
88001*	A19FR6-830-ECO-LED4	5.5W	E26	120V	3000K	80	450	15,000	No	1/48	4.13"	40W	85091
88002*	A19FR6-840-ECO-LED4	5.5W	E26	120V	4000K	80	450	15,000	No	1/48	4.13"	40W	85092
88003*	A19FR6-850-ECO-LED4	5.5W	E26	120V	5000K	80	450	15,000	No	1/48	4.13"	40W	85093
88004*	A19FR9-827-ECO-LED4	9W	E26	120V	2700K	80	800	15,000	No	1/48	4.13"	60W	85098
88005*	A19FR9-830-ECO-LED4	9W	E26	120V	3000K	80	800	15,000	No	1/48	4.13"	60W	85099
88006*	A19FR9-840-ECO-LED4	9W	E26	120V	4000K	80	800	15,000	No	1/48	4.13"	60W	85100
88007*	A19FR9-850-ECO-LED4	9W	E26	120V	5000K	80	800	15,000	No	1/48	4.13"	60W	85101
88054*	A19FR15-850-ECO-LED4	15W	E26	120V	5000K	80	1,600	15,000	No	1/48	4.64"	100W	85150

15,000 hour useful life rating is based on a maximum ambient temperature of 45°C. Exceeding this ambient temperature rating may result in reduced life.

* Phasing out-while supplies last

ProLED A19 Contractor Series 6-Pack (Gen-5)



Product #	Product Code	Wattage	Base	Voltage	Color Temp.	CRI	Lumens	Useful Life ¹	Dimmable	Pkg. Qty.	MOL	Eq. Wattage
85090	6A19-LED5-827-D	6W	E26	120V	2700K	80	420	15,000	Yes (Triac)	1/48	4.13"	40W
85091	6A19-LED5-830-D	6W	E26	120V	3000K	80	420	15,000	Yes (Triac)	1/48	4.13"	40W
85092	6A19-LED5-840-D	6W	E26	120V	4000K	80	420	15,000	Yes (Triac)	1/48	4.13"	40W
85093	6A19-LED5-850-D	6W	E26	120V	5000K	80	420	15,000	Yes (Triac)	1/48	4.13"	40W
85094	9A19-LED5-827-D	9W	E26	120V	2700K	80	800	15,000	Yes (Triac)	1/48	4.13"	60W
85095	9A19-LED5-830-D	9W	E26	120V	3000K	80	800	15,000	Yes (Triac)	1/48	4.13"	60W
85096	9A19-LED5-840-D	9W	E26	120V	4000K	80	800	15,000	Yes (Triac)	1/48	4.13"	60W
85097	9A19-LED5-850-D	9W	E26	120V	5000K	80	800	15,000	Yes (Triac)	1/48	4.13"	60W
85098	9A19-LED5-827-ND	9W	E26	120V	2700K	80	800	15,000	No	1/48	4.13"	60W
85099	9A19-LED5-830-ND	9W	E26	120V	3000K	80	800	15,000	No	1/48	4.13"	60W
85100	9A19-LED5-840-ND	9W	E26	120V	4000K	80	800	15,000	No	1/48	4.13"	60W
85101	9A19-LED5-850-ND	9W	E26	120V	5000K	80	800	15,000	No	1/48	4.13"	60W
85102	9A19-LED5-830-ND-6PK	9W	E26	120V	3000K	80	800	15,000	No	1/8	4.13"	60W
85103	11A19-LED5-827-D	11W	E26	120V	2700K	80	1100	15,000	Yes (Triac)	1/48	4.57"	75W
85104	11A19-LED5-830-D	11W	E26	120V	3000K	80	1100	15,000	Yes (Triac)	1/48	4.57"	75W
85105	11A19-LED5-840-D	11W	E26	120V	4000K	80	1100	15,000	Yes (Triac)	1/48	4.57"	75W
85106	11A19-LED5-850-D	11W	E26	120V	5000K	80	1100	15,000	Yes (Triac)	1/48	4.57"	75W
85107	15A19-LED5-827-D	15W	E26	120V	2700K	80	1600	15,000	Yes (Triac)	1/48	4.65"	100W
85108	15A19-LED5-830-D	15W	E26	120V	3000K	80	1600	15,000	Yes (Triac)	1/48	4.65"	100W
85109	15A19-LED5-840-D	15W	E26	120V	4000K	80	1600	15,000	Yes (Triac)	1/48	4.65"	100W
85110	15A19-LED5-850-D	15W	E26	120V	5000K	80	1600	15,000	Yes (Triac)	1/48	4.65"	100W
85111	15A19-LED5-827-ND	15W	E26	120V	2700K	80	1600	15,000	No	1/48	4.53"	100W
85112	15A19-LED5-830-ND	15W	E26	120V	3000K	80	1600	15,000	No	1/48	4.53"	100W
85113	15A19-LED5-840-ND	15W	E26	120V	4000K	80	1600	15,000	No	1/48	4.53"	100W
85114	15A19-LED5-850-ND	15W	E26	120V	5000K	80	1600	15,000	No	1/48	4.53"	100W

15,000 hour useful life rating is based on a maximum ambient temperature of 45°C. Exceeding this ambient temperature rating may result in reduced life.

* Phasing out-while supplies last



SPEC SHEET AVAILABLE HERE.

ProLED A19 Contractor Series 6-Pack



Product #	Product Code	Wattage	Base	Voltage	Color Temp.	CRI	Lumens	Useful Life ¹	Dimmable	Pkg. Qty.	MOL	Eq. Wattage	New Gen #
Non-Dimmable													
*88036	A19FR9-827-ECO-LED4-6pk	9W	E26	120V	2700K	80	800	15,000	No	6/48	4.13"	60W	N/A
*88037	A19FR9-830-ECO-LED4-6pk	9W	E26	120V	3000K	80	800	15,000	No	6/48	4.13"	60W	85102
*88038	A19FR9-840-ECO-LED4-6pk	9W	E26	120V	4000K	80	800	15,000	No	6/48	4.13"	60W	N/A
*88039	A19FR9-850-ECO-LED4-6pk	9W	E26	120V	5000K	80	800	15,000	No	6/48	4.13"	60W	N/A
Dimmable													
*88040	A19FR9-827-DIM-LED4-6pk	9W	E26	120V	2700K	80	800	15,000	Yes	6/48	4.13"	60W	N/A
*88041	A19FR9-830-DIM-LED4-6pk	9W	E26	120V	3000K	80	800	15,000	Yes	6/48	4.13"	60W	N/A
*88042	A19FR9-840-DIM-LED4-6pk	9W	E26	120V	4000K	80	800	15,000	Yes	6/48	4.13"	60W	N/A
*88043	A19FR9-850-DIM-LED4-6pk	9W	E26	120V	5000K	80	800	15,000	Yes	6/48	4.13"	60W	N/A
Dimmable-Title 20													
*88044	A19FR9-927-DIM-LED4-T20-6pk	9W	E26	120V	2700K	90+	800	15,000	Yes	6/48	4.33"	60W	N/A
*88045	A19FR9-930-DIM-LED4-T20-6pk	9W	E26	120V	3000K	90+	800	15,000	Yes	6/48	4.33"	60W	85102
*88046	A19FR9-940-DIM-LED4-T20-6pk	9W	E26	120V	4000K	90+	800	15,000	Yes	6/48	4.33"	60W	N/A
*88047	A19FR9-950-DIM-LED4-T20-6pk	9W	E26	120	5000K	90+	800	15,000	Yes	6/48	4.33"	60W	N/A

15,000 hour useful life rating is based on a maximum ambient temperature of 45°C. Exceeding this ambient temperature rating may result in reduced life.

* Phasing out-while supplies last

SPEC SHEET AVAILABLE HERE.

ProLED A19 Omnidirectional A-Shape Series (GU24 Base)



Product #	Product Code	Wattage	Base	Voltage	Color Temp	CRI	Lumens	Useful Life	Dimmable	Pkg. Qty.	MOL	Eq. Wattage	New Gen #
88055*	A19FR9-827-GU24-LED	9W	GU24	120V	2700K	80	800	15,000	No	1/48	4.17"	60W	85149
88056*	A19FR9-830-GU24-LED	9W	GU24	120V	3000K	80	800	15,000	No	1/48	4.17"	60W	85150
88057*	A19FR9-840-GU24-LED	9W	GU24	120V	4000K	80	800	15,000	No	1/48	4.17"	60W	85151
88058*	A19FR9-850-GU24-LED	9W	GU24	120V	5000K	80	800	15,000	No	1/48	4.17"	60W	85152
88059	A19FR11-827-GU24-LED	11W	GU24	121V	2700K	80	1,100	15,000	No	1/48	4.17"	75W	N/A
88060	A19FR15-840-GU24-LED	15W	GU24	122V	4000K	80	1,600	15,000	No	1/48	4.64"	100W	N/A

15,000 hour useful life rating is based on a maximum ambient temperature of 45°C. Exceeding this ambient temperature rating may result in reduced life.

* Phasing out-while supplies last

ProLED A19 GU24 Base Contractor & Performance Series Lamp (Gen-5)



Product #	Product Code	Wattage	Base	Voltage	Color Temp	CRI	Lumens	Useful Life	Dimmable	Pkg. Qty.	MOL	Eq. Wattage
85149	9A19-GU24-LED5-827-D	9W	GU24	120V	2700K	80	720 (800 Nominal)	15,000	Yes (Triac)	1/48	4.06"	60W
85150	9A19-GU24-LED5-830-D	9W	GU24	120V	3000K	80	720 (800 Nominal)	15,000	Yes (Triac)	1/48	4.06"	60W
85151	9A19-GU24-LED5-840-D	9W	GU24	120V	4000K	80	720 (800 Nominal)	15,000	Yes (Triac)	1/48	4.06"	60W
85152	9A19-GU24-LED5-850-D	9W	GU24	120V	5000K	80	720 (800 Nominal)	15,000	Yes (Triac)	1/48	4.06"	60W
85153	9A19-GU24-LED5-927-D-T20T24	9W	GU24	120V	2700K	90	800	15,000	Yes (Triac)	1/48	4.06"	60W
85154	9A19-GU24-LED5-930-D-T20T24	9W	GU24	120V	3000K	90	800	15,000	Yes (Triac)	1/48	4.06"	60W
85155	9A19-GU24-LED5-940-D-T20T24	9W	GU24	120V	4000K	90	800	15,000	Yes (Triac)	1/48	4.06"	60W
85156	9A19-GU24-LED5-950-D-T20	9W	GU24	120V	5000K	90	800	15,000	Yes (Triac)	1/48	4.06"	60W

15,000 hour useful life rating is based on a maximum ambient temperature of 45°C. Exceeding this ambient temperature rating may result in reduced life.

SPEC SHEET AVAILABLE HERE.

ProLED A19 Omidirectional A-Shape Series



Product #	Product Code	Wattage	Base	Voltage	Color Temp.	CRI	Lumens	Useful Life ¹	Dimmable	Pkg. Qty.	MOL	Eq. Wattage	New Gen #
A15													
88008*	A15FR5-827-DIM-LED4	5.5W	E26	120V	2700K	80	450	25,000	Yes	1/48	3.26"	40W	85132
88009*	A15FR5-830-DIM-LED4	5.5W	E26	120V	3000K	80	450	25,000	Yes	1/48	3.26"	40W	85133
88010*	A15FR5-840-DIM-LED4	5.5W	E26	120V	4000K	80	450	25,000	Yes	1/48	3.26"	40W	85134
88011*	A15FR5-850-DIM-LED4	5.5W	E26	120V	5000K	80	450	25,000	Yes	1/48	3.26"	40W	85135
A19													
88012*	A19FR6-827-DIM-LED4	5.5W	E26	120V	2700K	80	450	15,000	Yes	1/48	4.33"	40W	85090
88013*	A19FR6-830-DIM-LED4	5.5W	E26	120V	3000K	80	450	15,000	Yes	1/48	4.33"	40W	85091
88014*	A19FR6-840-DIM-LED4	5.5W	E26	120V	4000K	80	450	15,000	Yes	1/48	4.33"	40W	85092
88015*	A19FR6-850-DIM-LED4	5.5W	E26	120V	5000K	80	450	15,000	Yes	1/48	4.33"	40W	85093
88016*	A19FR9-827-DIM-LED4	9W	E26	120V	2700K	80	800	15,000	Yes	1/48	4.33"	60W	85094
88017*	A19FR9-830-DIM-LED4	9W	E26	120V	3000K	80	800	15,000	Yes	1/48	4.33"	60W	85095
88018*	A19FR9-840-DIM-LED4	9W	E26	120V	4000K	80	800	15,000	Yes	1/48	4.33"	60W	85096
88019*	A19FR9-850-DIM-LED4	9W	E26	120V	5000K	80	800	15,000	Yes	1/48	4.33"	60W	00000
88020*	A19FR11-827-DIM-LED4	11W	E26	120V	2700K	80	1,100	15,000	Yes	1/48	4.56"	75W	85103
88021*	A19FR11-830-DIM-LED4	11W	E26	120V	3000K	80	1,100	15,000	Yes	1/48	4.56"	75W	85104
88022*	A19FR11-840-DIM-LED4	11W	E26	120V	4000K	80	1,100	15,000	Yes	1/48	4.56"	75W	85105
88023*	A19FR11-850-DIM-LED4	11W	E26	120V	5000K	80	1,100	15,000	Yes	1/48	4.56"	75W	85106
88061*	A19FR15-827-DIM-LED	15W	E26	120V	2700K	80	1,600	25,000	Yes	1/48	4.65"	100W	85107
88062*	A19FR15-830-DIM-LED	15W	E26	120V	3000K	80	1,600	25,000	Yes	1/48	4.65"	100W	85108
88063*	A19FR15-840-DIM-LED	15W	E26	120V	4000K	80	1,600	25,000	Yes	1/48	4.65"	100W	85109
88064*	A19FR15-850-DIM-LED	15W	E26	120V	5000K	80	1,600	25,000	Yes	1/48	4.65"	100W	85110
A21													
88048*	A21FR17-827-DIM-LED4	17W	E26	120V	2700K	80	2,000	15,000	Yes	1/30	4.92"	125W	85107
88049*	A21FR17-830-DIM-LED4	17W	E26	120V	3000K	80	2,000	15,000	Yes	1/30	4.92"	125W	85108
88050*	A21FR17-840-DIM-LED4	17W	E26	120V	4000K	80	2,000	15,000	Yes	1/30	4.92"	125W	85109
88051*	A21FR17-850-DIM-LED4	17W	E26	120V	5000K	80	2,000	15,000	Yes	1/30	4.92"	125W	85110

* Phasing out-while supplies last

ProLED A19 Performance Series Lamp Title 20 (Gen-5)



Product #	Product Code	Wattage	Base	Voltage	Color Temp.	CRI	Lumens	Useful Life ¹	Dimmable	Pkg. Qty.	MOL	Eq. Wattage
85115	6A19-LED5-927-D-T20T24	5.5W	E26	120V	2700K	90	450	15,000	Yes (Triac)	1/48	4.13"	40W
85116	6A19-LED5-930-D-T20T24	5.5W	E26	120V	3000K	90	450	15,000	Yes (Triac)	1/48	4.13"	40W
85117	6A19-LED5-940-D-T20T24	5.5W	E26	120V	4000K	90	450	15,000	Yes (Triac)	1/48	4.13"	40W
85118	6A19-LED5-950-D-T20T24	5.5W	E26	120V	5000K	90	450	15,000	Yes (Triac)	1/48	4.13"	40W
85119	9A19-LED5-927-D-T20T24	9W	E26	120V	2700K	90	800	15,000	Yes (Triac)	1/48	4.13"	60W
85120	9A19-LED5-930-D-T20T24	9W	E26	120V	3000K	90	800	15,000	Yes (Triac)	1/48	4.13"	60W
85121	9A19-LED5-940-D-T20T24	9W	E26	120V	4000K	90	800	15,000	Yes (Triac)	1/48	4.13"	60W
85122	9A19-LED5-950-D-T20	9W	E26	120V	5000K	90	800	15,000	Yes (Triac)	1/48	4.13"	60W
85123	9A19-LED5-930-D-T20T24-6PK	9W	E26	120V	3000K	90	800	15,000	Yes (Triac)	1/8	4.13"	60W
85124	11A19-LED5-927-D-T20T24	11W	E26	120V	2700K	90	1,100	15,000	Yes (Triac)	1/48	4.57"	75W
85125	11A19-LED5-930-D-T20T24	11W	E26	120V	3000K	90	1,100	15,000	Yes (Triac)	1/48	4.57"	75W
85126	11A19-LED5-940-D-T20T24	11W	E26	120V	4000K	90	1,100	15,000	Yes (Triac)	1/48	4.57"	75W
85127	11A19-LED5-950-D-T20	11W	E26	120V	5000K	90	1,100	15,000	Yes (Triac)	1/48	4.57"	75W
85128	15A19-LED5-927-D-T20T24	15W	E26	120V	2700K	90	1,600	15,000	Yes (Triac)	1/48	4.65"	100W
85129	15A19-LED5-930-D-T20T24	15W	E26	120V	3000K	90	1,600	15,000	Yes (Triac)	1/48	4.65"	100W
85130	15A19-LED5-940-D-T20T24	15W	E26	120V	4000K	90	1,600	15,000	Yes (Triac)	1/48	4.65"	100W
85131	15A19-LED5-950-D-T20	15W	E26	120V	5000K	90	1,600	15,000	Yes (Triac)	1/48	4.65"	100W



ProLED A15 Contractor and Performance Series Lamp (Gen-5)



Product #	Product Code	Wattage	Base	Voltage	Color Temp.	CRI	Lumens	Useful Life ¹	Dimmable	Pkg. Qty.	MOL	Eq. Wattage
85132	6A15-LED5-827-D	5.5W	E26	120V	2700K	80	420 (450 Nominal)	15,000	Yes (Triac)	1/48	3.27"	40W
85133	6A15-LED5-830-D	5.5W	E26	120V	3000K	80	420 (450 Nominal)	15,000	Yes (Triac)	1/48	3.27"	40W
85134	6A15-LED5-840-D	5.5W	E26	120V	4000K	80	420 (450 Nominal)	15,000	Yes (Triac)	1/48	3.27"	40W
85135	6A15-LED5-850-D	5.5W	E26	120V	5000K	80	420 (450 Nominal)	15,000	Yes (Triac)	1/48	3.27"	40W
85136	6A15-LED5-927-D-T20T24	5.5W	E26	120V	2700K	80	420 (450 Nominal)	15,000	Yes (Triac)	1/48	3.27"	40W
85137	6A15-LED5-930-D-T20T24	5.5W	E26	120V	3000K	80	420 (450 Nominal)	15,000	Yes (Triac)	1/48	3.27"	40W
85138	6A15-LED5-940-D-T20T24	5.5W	E26	120V	4000K	80	420 (450 Nominal)	15,000	Yes (Triac)	1/48	3.27"	40W
85139	6A15-LED5-950-D-T20	5.5W	E26	120V	5000K	80	420 (450 Nominal)	15,000	Yes (Triac)	1/48	3.27"	40W

SPEC SHEET AVAILABLE HERE.

ProLED Performance A-Shape Lamp (Title 20)



Product #	Product Code	Wattage	Base	Voltage	Color Temp.	CRI	Lumens	Useful Life ¹	Dimmable	Pkg. Qty.	MOL	Eq. Wattage	New Gen #
88024*	A19FR6-927-DIM-LED4-T20	6W	E26	120V	2700K	90+	450	15,000	Yes	1/48	4.33"	40W	85115
88025*	A19FR6-930-DIM-LED4-T20	6W	E26	120V	3000K	90+	450	15,000	Yes	1/48	4.33"	40W	85116
88026*	A19FR6-940-DIM-LED4-T20	6W	E26	120V	4000K	90+	450	15,000	Yes	1/48	4.33"	40W	85117
88027*	A19FR6-950-DIM-LED4-T20	6W	E26	120V	5000K	90+	450	15,000	Yes	1/48	4.33"	40W	85118
88028*	A19FR9-927-DIM-LED4-T20	9W	E26	120V	2700K	90+	800	15,000	Yes	1/48	4.33"	60W	85119
88029*	A19FR9-930-DIM-LED4-T20	9W	E26	120V	3000K	90+	800	15,000	Yes	1/48	4.33"	60W	85120
88030*	A19FR9-940-DIM-LED4-T20	9W	E26	120V	4000K	90+	800	15,000	Yes	1/48	4.33"	60W	85121
88031*	A19FR9-950-DIM-LED4-T20	9W	E26	120V	5000K	90+	800	15,000	Yes	1/48	4.33"	60W	85122
88032*	A19FR12-927-DIM-LED4-T20	11W	E26	120V	2700K	90+	1,100	15,000	Yes	1/48	4.56"	75W	85124
88033*	A19FR12-930-DIM-LED4-T20	11W	E26	120V	3000K	90+	1,100	15,000	Yes	1/48	4.56"	75W	85125
88034*	A19FR12-940-DIM-LED4-T20	11W	E26	120V	4000K	90+	1,100	15,000	Yes	1/48	4.56"	75W	85126
88035*	A19FR12-950-DIM-LED4-T20	11W	E26	120V	5000K	90+	1,100	15,000	Yes	1/48	4.56"	75W	85127
88068*	A19FR15-950-DIM-LED-T20	15W	E26	120V	5000K	90+	1,600	25,000	Yes	1/48	4.65"	100W	85131
88052	A21-FR21-930-DIM-LED-T20	21W	E26	120V	5000K	90+	2,600	15,000	Yes	1/30	4.92"	150W	N/A
88053	A21-FR21-950-DIM-LED-T20	21W	E26	120V	5000K	90+	2,600	15,000	Yes	1/30	4.92"	150W	N/A

* Phasing out-while supplies last

SPEC SHEET AVAILABLE HERE.

ProLED Performance A-Shape Lamp Title 24/JA 8 & Title 20



Product #	Product Code	Wattage	Base	Voltage	Color Temp.	CRI	Lumens	Useful Life ¹	Dimmable ²	Pkg. Qty.	MOL	Eq. Wattage	New Gen #
88065*	A19FR15-927-DIM-LED-T20JA82019	15W	E26	120V	2700K	90+	1,600	25,000	Yes	1/48	4.65"	100W	85128
88066*	A19FR15-930-DIM-LED-T20JA82019	15W	E26	120V	3000K	90+	1,600	25,000	Yes	1/48	4.65"	100W	85129
88067*	A19FR15-940-DIM-LED-T20JA82019	15W	E26	120V	4000K	90+	1,600	25,000	Yes	1/48	4.65"	100W	85130

* Phasing out-while supplies last

Par & R Performance, Essential Series Product Selector

				Color Temperature				
				2700K	3000K	4000K	5000K	
BR30	Essential	Single PK		80290	80291	80292	80293	
		6PK		80294	80295	USE SINGLE PK		
	Performance	Single PK		80278	80279	80280	80281	
		6PK		USE SINGLE PK				
BR40	Essential	Single PK		80282	80283	80284	80285	
	Performance	Single PK		80286	80287	80288	80289	
R20	Essential	Single PK		80264	80265	80266	80267	
	Performance	Single PK		80268	80269	80270	80271	
PAR20	Essential	FLOOD	WHITE	80200	80201	80202	80203	
			BLACK	USE PERFORMANCE SERIES				
	NARROW FLOOD		WHITE	USE PERFORMANCE SERIES				
	Performance	FLOOD	WHITE	80208	80209	80210	80211	
		BLACK	80212	80213	80214	80215		
	NARROW FLOOD		WHITE	80204	80205	80206	80207	
PAR30	Essential	Short Neck	FLOOD	WHITE	80216	80217	80218	80219
				BLACK	USE PERFORMANCE SERIES			
		NARROW FLOOD		WHITE	USE PERFORMANCE SERIES			
		Long Neck	FLOOD	WHITE	80220	80221	80222	80223
			BLACK	USE PERFORMANCE SERIES				
	NARROW FLOOD		WHITE	USE PERFORMANCE SERIES				
	Performance	Short Neck	FLOOD	WHITE	80232	80233	80234	80235
				BLACK	80228	80229	80230	80231
NARROW FLOOD		WHITE	80224	80224	80226	80227		
Long Neck		FLOOD	WHITE	80244	80245	80246	80247	
		BLACK	80240	80241	80242	80243		
NARROW FLOOD		WHITE	80236	80237	80238	80239		
PAR38	Essential	FLOOD	WHITE	80248	80249	80250	80251	
			BLACK	USE PERFORMANCE SERIES				
	NARROW FLOOD		WHITE	USE PERFORMANCE SERIES				
	Performance	FLOOD	WHITE	80260	80261	80262	80263	
		BLACK	80256	80257	80258	80259		
NARROW FLOOD		WHITE	80252	80253	80254	80255		



SPEC SHEET AVAILABLE HERE.

ProLED BR40



Product #	Product Code	Wattage	Base	Voltage	Color Temp.	CRI	Lumens	Useful Life ¹	Dimmable ²	Pkg. Qty.	MOL	Eq. Wattage	New Gen #
*80981	BR40FL11/827/LED	11.5W	E26	120V	2700K	82	940	25,000	Yes	1/6	6.46"	75W	80282
*80980	BR40FL11/830/LED	11.5W	E26	120V	3000K	82	940	25,000	Yes	1/6	6.46"	75W	80283
*80983	BR40FL16/827/LED	16.5W	E26	120V	2700K	82	1,200	25,000	Yes	1/6	6.46"	85W	80282
*80982	BR40FL16/830/LED	16.5W	E26	120V	3000K	82	1,200	25,000	Yes	1/6	6.46"	85W	80283
*80984	BR40FL16/840/LED	16.5W	E26	120V	4000K	82	1,200	25,000	Yes	1/6	6.46"	85W	80284
*80985	BR40FL16/850/LED	16.5W	E26	120V	5000K	82	1,200	25,000	Yes	1/6	6.46"	85W	80285

*Phasing out-while supplies last

SPEC SHEET AVAILABLE HERE.

ProLED BR40 Essential



Product #	Product Code	Wattage	Base	Voltage	Color Temp.	CRI	Lumens	Useful Life ¹	Dimmable ²	Pkg. Qty.	MOL	Eq. Wattage	ENERGY STAR [®]
80282	13BR40-FL-LED-827-D-ES	13W	E26	120V	2700K	80	1100	25,000	Yes (Triac)	1/40	6.10"	75W	Yes
80283	13BR40-FL-LED-830-D-ES	13W	E26	120V	3000K	80	1100	25,000	Yes (Triac)	1/40	6.10"	75W	Yes
80284	13BR40-FL-LED-840-D-ES	13W	E26	120V	4000K	80	1100	25,000	Yes (Triac)	1/40	6.10"	75W	Yes
80285	13BR40-FL-LED-850-D-ES	13W	E26	120V	5000K	80	1100	25,000	Yes (Triac)	1/40	6.10"	75W	Yes

SPEC SHEET AVAILABLE HERE.

ProLED BR40 Performance



Product #	Product Code	Wattage	Base	Voltage	Color Temp.	CRI	Lumens	Useful Life ¹	Dimmable ²	Pkg. Qty.	MOL	Eq. Wattage	ENERGY STAR [®]
80286	13BR40-FL-LED-927-D-PS	13W	E26	120V	2700K	90	1100	25,000	Yes (Triac)	1/40	6.10"	80W	Yes
80287	13BR40-FL-LED-930-D-PS	13W	E26	120V	3000K	90	1100	25,000	Yes (Triac)	1/40	6.10"	80W	Yes
80288	13BR40-FL-LED-940-D-PS	13W	E26	120V	4000K	90	1100	25,000	Yes (Triac)	1/40	6.10"	80W	Yes
80289	13BR40-FL-LED-950-D-PS	13W	E26	120V	5000K	90	1100	25,000	Yes (Triac)	1/40	6.10"	80W	Yes

SPEC SHEET AVAILABLE HERE.

ProLED BR30



Product #	Product Code	Wattage	Base	Voltage	Color Temp.	CRI	Lumens	Useful Life ¹	Dimmable ²	Pkg. Qty.	MOL	Eq. Wattage	New Gen #
*80990	BR30FL8/827ECO/LED	8W	E26	120V	2700K	82	650	25,000	Yes	1/6	5.12"	65W	80290
*80991	BR30FL8/830/ECOLED	8W	E26	120V	3000K	82	650	25,000	Yes	1/6	5.12"	65W	80291
80988	BR30FL8/PNK/LED	8W	E26	120V	Pink	82	-	40,000	Yes	1/6	5.12"	65W	Still Active
*80976	BR30FL10/827/LED	9.5W	E26	120V	2700K	82	750	25,000	Yes	1/6	5.12"	65W	80290
*80977	BR30FL10/830/LED	9.5W	E26	120V	3000K	82	750	25,000	Yes	1/6	5.12"	65W	80291
*80978	BR30FL10/840/LED	9.5W	E26	120V	4000K	82	750	25,000	Yes	1/6	5.12"	65W	80292
*80979	BR30FL10/850/LED	9.5W	E26	120V	5000K	82	750	25,000	Yes	1/6	5.12"	65W	80293

15,000 hour useful life rating is based on a maximum ambient temperature of 45°C. Exceeding this ambient temperature rating may result in reduced life.
 * Phasing out-while supplies last

SPEC SHEET AVAILABLE HERE.

ProLED BR30 Essential



Product #	Product Code	Wattage	Base	Voltage	Color Temp.	CRI	Lumens	Useful Life ¹	Dimmable ²	Pkg. Qty.	MOL	Eq. Wattage	ENERGY STAR [®]
80290	8BR30-FL-LED-827-DIM-ES	8W	E26	120V	2700K	80	650	25,000	Yes (Triac)	1/50	4.96"	65W	Yes
80291	8BR30-FL-LED-830-DIM-ES	8W	E26	120V	3000K	80	650	25,000	Yes (Triac)	1/50	4.96"	65W	Yes
80292	8BR30-FL-LED-840-DIM-ES	8W	E26	120V	4000K	80	650	25,000	Yes (Triac)	1/50	4.96"	65W	Yes
80293	8BR30-FL-LED-850-DIM-ES	8W	E26	120V	5000K	80	650	25,000	Yes (Triac)	1/50	4.96"	65W	Yes

15,000 hour useful life rating is based on a maximum ambient temperature of 45°C. Exceeding this ambient temperature rating may result in reduced life.

SPEC SHEET AVAILABLE HERE.

ProLED BR30 Contractor Series 6-Pack



Product #	Product Code	Wattage	Base	Voltage	Color Temp.	CRI	Lumens	Useful Life ¹	Dimmable ²	Pkg. Qty.	MOL	Eq. Wattage	New Gen #
*82172	BR30FL8/827/ECO/LED/6	8W	E26	120V	2700K	82	650	15,000	Yes	6/24	5.20"	65W	80294
*82170	BR30FL8/830/ECO/LED/6	8W	E26	120V	3000K	82	650	15,000	Yes	6/24	5.20"	65W	80295

15,000 hour useful life rating is based on a maximum ambient temperature of 45°C. Exceeding this ambient temperature rating may result in reduced life.
 * Phasing out-while supplies last

SPEC SHEET AVAILABLE HERE.

ProLED BR30 Essential 6-PACK



Product #	Product Code	Wattage	Base	Voltage	Color Temp.	CRI	Lumens	Useful Life ¹	Dimmable ²	Pkg. Qty.	MOL	Eq. Wattage	ENERGY STAR [®]
80294	8BR30-FL-LED-827-DIM-ES-6-PK	8W	E26	120V	2700K	80	650	25,000	Yes (Triac)	1/8	4.96"	65W	Yes
80295	8BR30-FL-LED-830-DIM-ES-6-PK	8W	E26	120V	3000K	80	650	25,000	Yes (Triac)	1/8	4.96"	65W	Yes

15,000 hour useful life rating is based on a maximum ambient temperature of 45°C. Exceeding this ambient temperature rating may result in reduced life.



SPEC SHEET AVAILABLE HERE.

ProLED BR30 Performance



Product #	Product Code	Wattage	Base	Voltage	Color Temp.	CRI	Lumens	Useful Life ¹	Dimmable ²	Pkg. Qty.	MOL	Eq. Wattage	ENERGY STAR [®]
80278	10BR30-FL-LED-927-D-PS	9.5W	E26	120V	2700K	90	800	25,000	Yes (Triac)	1/50	4.96"	65W	Yes
80279	10BR30-FL-LED-930-D-PS	9.5W	E26	120V	3000K	90	800	25,000	Yes (Triac)	1/50	4.96"	65W	Yes
80280	10BR30-FL-LED-940-D-PS	9.5W	E26	120V	4000K	90	800	25,000	Yes (Triac)	1/50	4.96"	65W	Yes
80281	10BR30-FL-LED-950-D-PS	9.5W	E26	120V	5000K	90	800	25,000	Yes (Triac)	1/50	4.96"	65W	Yes

SPEC SHEET AVAILABLE HERE.

ProLED R20



Product #	Product Code	Wattage	Base	Voltage	Color Temp.	CRI	Lumens	Useful Life ¹	Dimmable ²	Pkg. Qty.	MOL	Eq. Wattage	New Gen #
*80989	R20FL6/827/LED	6.5W	E26	120V	2700K	82	525	25,000	Yes	1/6	3.94"	50W	80264
*80986	R20FL6/830/LED	6.5W	E26	120V	3000K	82	525	25,000	Yes	1/6	3.94"	50W	80265
*81164	R20FL6/840/LED	6.5W	E26	120V	4000K	82	525	25,000	Yes	1/6	3.94"	50W	80266
*80987	R20FL6/850/LED	6.5W	E26	120V	5000K	82	525	25,000	Yes	1/6	3.94"	50W	80267

* Phasing out-while supplies last

SPEC SHEET AVAILABLE HERE.

ProLED R20 Essential



Product #	Product Code	Wattage	Base	Voltage	Color Temp.	CRI	Lumens	Useful Life ¹	Dimmable ²	Pkg. Qty.	MOL	Eq. Wattage	ENERGY STAR [®]
80264	7R20-FL-LED-827-D-ES	7W	E26	120V	2700K	80	500	25,000	Yes (Triac)	1/96	3.82"	50W	Yes
80265	7R20-FL-LED-830-D-ES	7W	E26	120V	3000K	80	500	25,000	Yes (Triac)	1/96	3.82"	50W	Yes
80266	7R20-FL-LED-840-D-ES	7W	E26	120V	4000K	80	500	25,000	Yes (Triac)	1/96	3.82"	50W	Yes
80267	7R20-FL-LED-850-D-ES	7W	E26	120V	5000K	80	500	25,000	Yes (Triac)	1/96	3.82"	50W	Yes

SPEC SHEET AVAILABLE HERE.

ProLED R20 Performance



Product #	Product Code	Wattage	Base	Voltage	Color Temp.	CRI	Lumens	Useful Life ¹	Dimmable ²	Pkg. Qty.	MOL	Eq. Wattage	ENERGY STAR [®]
80268	6R20-FL-LED-927-D-PS	6W	E26	120V	2700K	90	550	25,000	Yes (Triac)	1/96	3.82"	50W	Yes
80269	6R20-FL-LED-930-D-PS	6W	E26	120V	3000K	90	550	25,000	Yes (Triac)	1/96	3.82"	50W	Yes
80270	6R20-FL-LED-940-D-PS	6W	E26	120V	4000K	90	550	25,000	Yes (Triac)	1/96	3.82"	50W	Yes
80271	6R20-FL-LED-950-D-PS	6W	E26	120V	5000K	90	550	25,000	Yes (Triac)	1/96	3.82"	50W	Yes

[SPEC SHEET AVAILABLE HERE.](#)

ProLED Prime PAR Series



Product #	Product Code	Description	Wattage	Base	Voltage	Color Temp.	CRI	Lumens	CBCP	Useful Life ¹	Dimmable ²	Pkg. Qty.	Beam Spread	MOL	Eq. Wattage	New Gen #
PAR20																
*83142	PAR20NFL7/927/WH/LED2	Narrow Flood, White	7W	E26	120V	2700K	90	550	2500	50,000	Yes	6/24	25°	3.14"	50W	80204
*83143	PAR20NFL7/930/WH/LED2	Narrow Flood, White	7W	E26	120V	3000K	90	550	2500	50,000	Yes	6/24	25°	3.14"	50W	80205
*83144	PAR20NFL7/930/BH/LED2	Narrow Flood, Black	7W	E26	120V	3000K	90	550	2500	50,000	Yes	6/24	25°	3.14"	50W	none
*83145	PAR20NFL7/940/WH/LED2	Narrow Flood, White	7W	E26	120V	4000K	90	550	2500	50,000	Yes	6/24	25°	3.14"	50W	80206
*83146	PAR20NFL7/950/WH/LED2	Narrow Flood, White	7W	E26	120V	2700K	90	550	2500	50,000	Yes	6/24	25°	3.14"	50W	80207
*83147	PAR20FL7/927/WH/LED2	Flood, White	7W	E26	120V	2700K	90	550	1000	50,000	Yes	6/24	40°	3.14"	50W	80208
*83148	PAR20FL7/927/BH/LED2	Flood, Black	7W	E26	120V	2700K	90	550	1000	50,000	Yes	6/24	40°	3.14"	50W	80212
*83149	PAR20FL7/930/WH/LED2	Flood, White	7W	E26	120V	3000K	90	550	1000	50,000	Yes	6/24	40°	3.14"	50W	80209
*83150	PAR20FL7/930/BH/LED2	Flood, Black	7W	E26	120V	3000K	90	550	1000	50,000	Yes	6/24	40°	3.14"	50W	80213
*83151	PAR20FL7/940/WH/LED2	Flood, White	7W	E26	120V	4000K	90	500	865	50,000	Yes	6/24	40°	3.39"	50W	80210
*83152	PAR20FL7/940/BH/LED2	Flood, Black	7W	E26	120V	4000K	90	500	865	50,000	Yes	6/24	40°	3.39"	50W	80214
*83153	PAR20FL7/950/WH/LED2	Flood, White	7W	E26	120V	5000K	90	550	1000	50000	Yes	6/24	40°	3.14"	50W	80211
PAR30 Long Neck																
*83200	PAR30FL12L/927/WH/LED2	Flood, White	12W	E26	120V	2700K	90	1,050	2300	50,000	Yes	6/24	40°	4.37"	75W	80244
*83202	PAR30FL12L/930/WH/LED2	Flood, White	12W	E26	120V	3000K	90	1,050	2300	50,000	Yes	6/24	40°	4.37"	75W	80245
*83203	PAR30FL12L/930/BH/LED2	Flood, Black	12W	E26	120V	3000K	90	1,050	2300	50,000	Yes	6/24	40°	4.37"	75W	80241
*83204	PAR30FL12L/940/WH/LED2	Flood, White	12W	E26	120V	4000K	90	1,050	2300	50,000	Yes	6/24	40°	4.37"	75W	80246
*83205	PAR30FL12L/940/BH/LED2	Flood, Black	12W	E26	120V	4000K	90	1,050	2300	50,000	Yes	6/24	40°	4.37"	75W	80242
*83206	PAR30FL12L/950/WH/LED2	Flood, White	12W	E26	120V	5000K	90	1,050	2300	50,000	Yes	6/24	40°	4.37"	75W	80247
*83207	PAR30NFL12L/927/WH/LED2	Narrow Flood, White	12W	E26	120V	2700K	90	1,050	4815	50,000	Yes	6/24	25°	4.37"	75W	80236
*83209	PAR30NFL12L/930/WH/LED2	Narrow Flood, White	12W	E26	120V	3000K	90	1,050	4675	50,000	Yes	6/24	25°	4.37"	75W	80237
*83210	PAR30NFL12L/950/WH/LED2	Narrow Flood, White	12W	E26	120V	5000K	90	1,050	4675	50,000	Yes	6/24	25°	4.37"	75W	80239
PAR30 Short Neck																
*83111	PAR30FL12S/927/WH/LED2	Flood, White	12W	E26	120V	2700K	90	1,050	2300	50,000	Yes	6/24	40°	3.26"	75W	80232
*83112	PAR30FL12S/927/BH/LED2	Flood, Black	12W	E26	120V	2700K	90	1,050	2300	50,000	Yes	6/24	40°	3.26"	75W	80228
*83113	PAR30FL12S/930/WH/LED2	Flood, White	12W	E26	120V	3000K	90	1,050	2300	50,000	Yes	6/24	40°	3.26"	75W	80233
*83114	PAR30FL12S/930/BH/LED2	Flood, Black	12W	E26	120V	3000K	90	1,050	2300	50,000	Yes	6/24	40°	3.26"	75W	80229
*83115	PAR30FL12S/940/WH/LED	Flood, White	12W	E26	120V	4000K	90	1,050	2300	50,000	Yes	6/24	40°	3.26"	75W	80234
*83116	PAR30FL12S/940/BH/LED2	Flood, Black	12W	E26	120V	4000K	90	1,050	2300	50,000	Yes	6/24	40°	3.26"	75W	80230
*83118	PAR30FL12S/950/WH/LED2	Flood, White	12W	E26	120V	5000K	90	1,050	2300	50,000	Yes	6/24	40°	3.26"	75W	80235
*83208	PAR30NFL12S/927/WH/LED2	Narrow Flood, White	12W	E26	120V	2700K	90	1,050	4800	50,000	Yes	6/24	25°	3.26"	75W	80224
*83120	PAR30NFL12S/930/WH/LED2	Narrow Flood, White	12W	E26	120V	3000K	90	1,050	4800	50,000	Yes	6/24	25°	3.26"	75W	80225
*83121	PAR30NFL12S/930/BH/LED2	Narrow Flood, Black	12W	E26	120V	3000K	90	1,050	4800	50,000	Yes	6/24	25°	3.26"	75W	None
*83122	PAR30NFL12S/940/WH/LED2	Narrow Flood, White	12W	E26	120V	4000K	90	1,050	4800	50,000	Yes	6/24	25°	3.26"	75W	80226

* Phasing out-while supplies last

Continue to next page for additional product information



ProLED Prime PAR Series

Product #	Product Code	Description	Wattage	Base	Voltage	Color Temp.	CRI	Lumens	CBCP	Useful Life ¹	Dimmable ²	Pkg. Qty.	Beam Spread	MOL	Eq. Wattage	New Gen #
PAR38																
*83123	PAR38FL17/927/WH/LED2	Flood, White	17W	E26	120V	2700K	90	1,370	2800	50,000	Yes	6/24	40°	5.11"	120W	80260
*83124	PAR38FL17/927/BH/LED2	Flood, Black	17W	E26	120V	2700K	90	1,370	2800	50,000	Yes	6/24	40°	5.11"	120W	80256
*83125	PAR38FL17/930/WH/LED2	Flood, White	17W	E26	120V	3000K	90	1,370	2800	50,000	Yes	6/24	40°	5.11"	120W	80261
*83126	PAR38FL17/930/BH/LED2	Flood, Black	17W	E26	120V	3000K	90	1,370	2800	50,000	Yes	6/24	40°	5.11"	120W	80257
*83127	PAR38FL17/940/WH/LED2	Flood, White	17W	E26	120V	4000K	90	1,370	2800	50,000	Yes	6/24	40°	5.11"	120W	80262
*83129	PAR38FL17/950/WH/LED2	Flood, White	17W	E26	120V	5000K	90	1,370	2800	50,000	Yes	6/24	40°	5.11"	120W	80263
*83130	PAR38NFL17/927/WH/LED2	Narrow Flood, White	17W	E26	120V	2700K	90	1,370	2800	50,000	Yes	6/24	40°	5.11"	120W	80252
*83131	PAR38NFL17/927/BH/LED2	Narrow Flood, Black	17W	E26	120V	2700K	90	1,370	7400	50,000	Yes	6/24	25°	5.11"	120W	80256
*83132	PAR38NFL17/930/WH/LED2	Narrow Flood, White	17W	E26	120V	3000K	90	1,370	7400	50,000	Yes	6/24	25°	5.11"	120W	80253
*83134	PAR38NFL17/940/WH/LED2	Narrow Flood, White	17W	E26	120V	4000K	90	1,370	7400	50,000	Yes	6/24	25°	5.11"	120W	80254
*83135	PAR38NFL17/950/WH/LED2	Narrow Flood, White	17W	E26	120V	5000K	90	1370	7400	50,000	Yes	6/24	25°	5.11"	120W	80255

For details on ProLED PAR16, see ProLED Commercial MR16/PAR16 Series Sell Sheet. Not for use in enclosed fixtures.

* Phasing out-while supplies last

SPEC SHEET AVAILABLE HERE.

ProLED ECO PAR Series



Product #	Product Code	Description	Wattage	Base	Voltage	Color Temp.	CRI	Lumens	CBCP	Useful Life ¹	Dimmable ²	Pkg. Qty.	Beam Spread	MOL	Eq. Wattage	New Gen #
PAR20																
*82963	PAR20FL7/827/ECO2/LED	Flood	7W	E26	120V	2700K	82	500	600	25,000	Yes	1/20	40°	3.39"	50W	80200
*82964	PAR20FL7/830/ECO2/LED	Flood	7W	E26	120V	3000K	82	530	600	25,000	Yes	1/20	40°	3.39"	50W	80201
*82965	PAR20FL7/840/ECO2/LED	Flood	7W	E26	120V	4000K	82	550	600	25,000	Yes	1/20	40°	3.39"	50W	80202
*82966	PAR20FL7/850/ECO2/LED	Flood	7W	E26	120V	5000K	82	570	600	25,000	Yes	1/20	40°	3.39"	50W	80203
PAR30L																
*82958	PAR30FL10L/827/ECO2/LED	Flood	10W	E26	120V	2700K	82	760	1120	25,000	Yes	1/15	40°	4.61"	60W	80220
*82959	PAR30FL10L/830/ECO2/LED	Flood	10W	E26	120V	3000K	82	800	1120	25,000	Yes	1/15	40°	4.61"	60W	80221
*82960	PAR30FL10L/840/ECO2/LED	Flood	10W	E26	120V	4000K	82	840	1120	25,000	Yes	1/15	40°	4.61"	60W	80222
*82967	PAR30FL10L/850/ECO2/LED	Flood	10W	E26	120V	5000K	82	880	1120	25,000	Yes	1/15	40°	4.61"	60W	80223
*82968	PAR30NFL10L/830/ECO2/LED	Narrow Flood	10W	E26	120V	3000K	82	800	1120	25,000	Yes	1/15	25°	4.61"	60W	80237
PAR30S																
*81961	PAR30FL10S/827/ECO2/LED	Flood	10W	E26	120V	2700K	82	760	960	25,000	Yes	1/15	40°	3.35"	75W	80216
*81962	PAR30FL10S/830/ECO2/LED	Flood	10W	E26	120V	3000K	82	800	960	25,000	Yes	1/15	40°	3.35"	75W	80217
*82969	PAR30FL10S/840/ECO2/LED	Flood	10W	E26	120V	4000K	82	840	960	25,000	Yes	1/15	40°	3.35"	75W	80218
*82970	PAR30FL10S/850/ECO2/LED	Flood	10W	E26	120V	5000K	82	880	960	25,000	Yes	1/15	40°	3.35"	75W	80219
*82971	PAR30NFL10S/830/ECO2/LED	Narrow Flood	10W	E26	120V	3000K	82	800	960	25,000	Yes	1/15	25°	3.35"	75W	none

* Phasing out-while supplies last



SPEC SHEET AVAILABLE HERE.

ProLED PAR20 Essential

Product #	Product Code	Wattage	Base	Voltage	Color Temp.	CRI	Lumens	Useful Life ¹	Dimmable ²	Pkg. Qty.	MOL	Eq. Wattage	ENERGY STAR [®]
80200	7PAR20-FL-LED-827-D-ES	6.5W	E26	120V	2700K	80	550	25,000	Yes (Triac)	1/96	3.11"	50W	Yes
80201	7PAR20-FL-LED-830-D-ES	6.5W	E26	120V	3000K	80	550	25,000	Yes (Triac)	1/96	3.11"	50W	Yes
80202	7PAR20-FL-LED-840-D-ES	6.5W	E26	120V	4000K	80	550	25,000	Yes (Triac)	1/96	3.11"	50W	Yes
80203	7PAR20-FL-LED-850-D-ES	6.5W	E26	120V	5000K	80	550	25,000	Yes (Triac)	1/96	3.11"	50W	Yes

SPEC SHEET AVAILABLE HERE.

ProLED PAR30 Essential



Product #	Product Code	Wattage	Base	Voltage	Color Temp.	CRI	Lumens	Useful Life ¹	Dimmable ²	Pkg. Qty.	MOL	Eq. Wattage	ENERGY STAR [®]
PAR30S													
80216	11PAR30S-FL-LED-827-D-ES	11W	E26	120V	2700K	80	850	25,000	Yes (Triac)	1/50	3.74"	75W	Yes
80217	11PAR30S-FL-LED-830-D-ES	11W	E26	120V	3000K	80	850	25,000	Yes (Triac)	1/50	3.74"	75W	Yes
80218	11PAR30S-FL-LED-840-D-ES	11W	E26	120V	4000K	80	850	25,000	Yes (Triac)	1/50	3.74"	75W	Yes
80219	11PAR30S-FL-LED-850-D-ES	11W	E26	120V	5000K	80	850	25,000	Yes (Triac)	1/50	3.74"	75W	Yes
PAR30L													
80220	11PAR30L-FL-LED-827-D-ES	11W	E26	120V	2700K	80	850	25,000	Yes (Triac)	1/50	4.61"	75W	Yes
80221	11PAR30L-FL-LED-830-D-ES	11W	E26	120V	3000K	80	850	25,000	Yes (Triac)	1/50	4.61"	75W	Yes
80222	11PAR30L-FL-LED-840-D-ES	11W	E26	120V	4000K	80	850	25,000	Yes (Triac)	1/50	4.61"	75W	Yes
80223	11PAR30L-FL-LED-850-D-ES	11W	E26	120V	5000K	80	850	25,000	Yes (Triac)	1/50	4.61"	75W	Yes

SPEC SHEET AVAILABLE HERE.

ProLED PAR38 Essential



Product #	Product Code	Wattage	Base	Voltage	Color Temp.	CRI	Lumens	Useful Life ¹	Dimmable ²	Pkg. Qty.	MOL	Eq. Wattage	ENERGY STAR [®]
80248	13PAR38-FL-LED-827-D-ES	13W	E26	120V	2700K	80	1200	25,000	Yes (Triac)	1/40	5.35"	90W	Yes
80249	13PAR38-FL-LED-830-D-ES	13W	E26	120V	3000K	80	1200	25,000	Yes (Triac)	1/40	5.35"	90W	Yes
80250	13PAR38-FL-LED-840-D-ES	13W	E26	120V	4000K	80	1200	25,000	Yes (Triac)	1/40	5.35"	90W	Yes
80251	13PAR38-FL-LED-850-D-ES	13W	E26	120V	5000K	80	1200	25,000	Yes (Triac)	1/40	5.35"	90W	Yes



[SPEC SHEET AVAILABLE HERE.](#)

ProLED Performance PAR Lamps



Product #	Product Code	Wattage	Base	Voltage	Color Temp.	CRI	Lumens	Useful Life ¹	Dimmable ²	Pkg. Qty.	MOL	Eq. Wattage	New Gen #
*84987	PAR30FL12S/927/T20/LED	12W	E26	120V	2700K	94	975	25,000	Yes	1/48	3.74"	75W	80232
*84988	PAR30FL12S/930/T20/LED	12W	E26	120V	3000K	94	975	25,000	Yes	1/48	3.74"	75W	80233
*84989	PAR30FL12S/940/T20/LED	12W	E26	120V	4000K	94	975	25,000	Yes	1/48	3.74"	75W	80234
*84990	PAR30FL12S/950/T20/LED	12W	E26	120V	5000K	94	975	25,000	Yes	1/48	3.74"	75W	80235
*84991	PAR30FL12L/927/T20/LED	12W	E26	120V	2700K	94	975	25,000	Yes	1/48	4.41"	75W	80244
*84992	PAR30FL12L/930/T20/LED	12W	E26	120V	3000K	94	975	25,000	Yes	1/48	4.41"	75W	80245
*84993	PAR30FL12L/940/T20/LED	12W	E26	120V	4000K	94	975	25,000	Yes	1/48	4.41"	75W	80246
*84994	PAR30FL12L/950/T20/LED	12W	E26	120V	5000K	94	975	25,000	Yes	1/48	4.41"	75W	80247
*84995	PAR38FL15/927/T20/LED	15W	E26	120V	2700K	94	1,250	25,000	Yes	1/30	4.88"	90W	80260
*84996	PAR38FL15/930/T20/LED	15W	E26	120V	3000K	94	1,250	25,000	Yes	1/30	4.88"	90W	80261
*84997	PAR38FL15/940/T20/LED	15W	E26	120V	4000K	94	1,250	25,000	Yes	1/30	4.88"	90W	80262
*84998	PAR38FL15/950/T20/LED	15W	E26	120V	5000K	94	1,250	25,000	Yes	1/30	4.88"	90W	80263

* Phasing out-while supplies last

[SPEC SHEET AVAILABLE HERE.](#)

ProLED PAR20 Performance Lamps



Product #	Product Code	Wattage	Base	Voltage	Color Temp.	CRI	Lumens	Useful Life ¹	Dimmable ²	Pkg. Qty.	MOL	Eq. Wattage	ENERGY STAR [®]
80208	7PAR20-FL-LED-927-D-PS	6.5W	E26	120V	2700K	90	550	40,000	Yes (Triac)	1/96	3.11"	40W	Yes
80209	7PAR20-FL-LED-930-D-PS	6.5W	E26	120V	3000K	90	550	40,000	Yes (Triac)	1/96	3.11"	40W	Yes
80210	7PAR20-FL-LED-940-D-PS	6.5W	E26	120V	4000K	90	550	40,000	Yes (Triac)	1/96	3.11"	40W	Yes
80211	7PAR20-FL-LED-950-D-PS	6.5W	E26	120V	5000K	90	550	40,000	Yes (Triac)	1/96	3.11"	40W	Yes
80212	7PAR20-FL-LED-927-D-BLK-PS	6.5W	E26	120V	2700K	90	550	40,000	Yes (Triac)	1/96	3.11"	40W	Yes
80213	7PAR20-FL-LED-930-D-BLK-PS	6.5W	E26	120V	3000K	90	550	40,000	Yes (Triac)	1/96	3.11"	40W	Yes
80214	7PAR20-FL-LED-940-D-BLK-PS	6.5W	E26	120V	4000K	90	550	40,000	Yes (Triac)	1/96	3.11"	40W	Yes
80215	7PAR20-FL-LED-950-D-BLK-PS	6.5W	E26	120V	5000K	90	550	40,000	Yes (Triac)	1/96	3.11"	40W	Yes
80204	7PAR20-NFL-LED-927-D-PS	6.5W	E26	120V	2700K	90	550	40,000	Yes (Triac)	1/96	3.11"	40W	Yes
80205	7PAR20-NFL-LED-930-D-PS	6.5W	E26	120V	3000K	90	550	40,000	Yes (Triac)	1/96	3.11"	40W	Yes
80206	7PAR20-NFL-LED-940-D-PS	6.5W	E26	120V	4000K	90	550	40,000	Yes (Triac)	1/96	3.11"	40W	Yes
80207	7PAR20-NFL-LED-950-D-PS	6.5W	E26	120V	5000K	90	550	40,000	Yes (Triac)	1/96	3.11"	40W	Yes

SPEC SHEET AVAILABLE HERE.

ProLED PAR30 Performance Lamps



Product #	Product Code	Wattage	Base	Voltage	Color Temp.	CRI	Lumens	Useful Life ¹	Dimmable ²	Pkg. Qty.	MOL	Eq. Wattage	ENERGY STAR®
80232	11PAR30S-FL-LED-927-D-PS	11W	E26	120V	2700K	90	1000	40,000	Yes (Triac)	1/50	3.74"	75W	Yes
80233	11PAR30S-FL-LED-930-D-PS	11W	E26	120V	3000K	90	1000	40,000	Yes (Triac)	1/50	3.74"	75W	Yes
80234	11PAR30S-FL-LED-940-D-PS	11W	E26	120V	4000K	90	1000	40,000	Yes (Triac)	1/50	3.74"	75W	Yes
80235	11PAR30S-FL-LED-950-D-PS	11W	E26	120V	5000K	90	1000	40,000	Yes (Triac)	1/50	3.74"	75W	Yes
80224	11PAR30S-NFL-LED-927-D-PS	11W	E26	120V	2700K	90	1000	40,000	Yes (Triac)	1/50	3.74"	75W	Yes
80225	11PAR30S-NFL-LED-930-D-PS	11W	E26	120V	3000K	90	1000	40,000	Yes (Triac)	1/50	3.74"	75W	Yes
80226	11PAR30S-NFL-LED-940-D-PS	11W	E26	120V	4000K	90	1000	40,000	Yes (Triac)	1/50	3.74"	75W	Yes
80227	11PAR30S-NFL-LED-950-D-PS	11W	E26	120V	5000K	90	1000	40,000	Yes (Triac)	1/50	3.74"	75W	Yes
80244	11PAR30L-FL-LED-927-D-PS	11W	E26	120V	2700K	90	1000	40,000	Yes (Triac)	1/50	4.61"	75W	Yes
80245	11PAR30L-FL-LED-930-D-PS	11W	E26	120V	3000K	90	1000	40,000	Yes (Triac)	1/50	4.61"	75W	Yes
80246	11PAR30L-FL-LED-940-D-PS	11W	E26	120V	4000K	90	1000	40,000	Yes (Triac)	1/50	4.61"	75W	Yes
80247	11PAR30L-FL-LED-950-D-PS	11W	E26	120V	5000K	90	1000	40,000	Yes (Triac)	1/50	4.61"	75W	Yes
80236	11PAR30L-NFL-LED-927-D-PS	11W	E26	120V	2700K	90	1000	40,000	Yes (Triac)	1/50	4.61"	75W	Yes
80237	11PAR30L-NFL-LED-930-D-PS	11W	E26	120V	3000K	90	1000	40,000	Yes (Triac)	1/50	4.61"	75W	Yes
80238	11PAR30L-NFL-LED-940-D-PS	11W	E26	120V	4000K	90	1000	40,000	Yes (Triac)	1/50	4.61"	75W	Yes
80239	11PAR30L-NFL-LED-950-D-PS	11W	E26	120V	5000K	90	1000	40,000	Yes (Triac)	1/50	4.61"	75W	Yes
80228	11PAR30S-FL-LED-927-D-BLK-PS	11W	E26	120V	2700K	90	1000	40,000	Yes (Triac)	1/50	3.74"	75W	Yes
80229	11PAR30S-FL-LED-930-D-BLK-PS	11W	E26	120V	3000K	90	1000	40,000	Yes (Triac)	1/50	3.74"	75W	Yes
80230	11PAR30S-FL-LED-940-D-BLK-PS	11W	E26	120V	4000K	90	1000	40,000	Yes (Triac)	1/50	3.74"	75W	Yes
80231	11PAR30S-FL-LED-950-D-BLK-PS	11W	E26	120V	5000K	90	1000	40,000	Yes (Triac)	1/50	3.74"	75W	Yes
80240	11PAR30L-FL-LED-927-D-BLK-PS	11W	E26	120V	2700K	90	1000	40,000	Yes (Triac)	1/50	4.61"	75W	Yes
80241	11PAR30L-FL-LED-930-D-BLK-PS	11W	E26	120V	3000K	90	1000	40,000	Yes (Triac)	1/50	4.61"	75W	Yes
80242	11PAR30L-FL-LED-940-D-BLK-PS	11W	E26	120V	4000K	90	1000	40,000	Yes (Triac)	1/50	4.61"	75W	Yes
80243	11PAR30L-FL-LED-950-D-BLK-PS	11W	E26	120V	5000K	90	1000	40,000	Yes (Triac)	1/50	4.61"	75W	Yes



SPEC SHEET AVAILABLE HERE.

ProLED PAR38 Performance Lamps

Product #	Product Code	Wattage	Base	Voltage	Color Temp.	CRI	Lumens	Useful Life ¹	Dimmable ²	Pkg. Qty.	MOL	Eq. Wattage	ENERGY STAR [®]
80260	14PAR38-FL-LED-927-D-PS	14W	E26	120V	2700K	90	1400	40,000	Yes (Triac)	1/40	5.35"	90W	Yes
80261	14PAR38-FL-LED-930-D-PS	14W	E26	120V	3000K	90	1400	40,000	Yes (Triac)	1/40	5.35"	90W	Yes
80262	14PAR38-FL-LED-940-D-PS	14W	E26	120V	4000K	90	1400	40,000	Yes (Triac)	1/40	5.35"	90W	Yes
80263	14PAR38-FL-LED-950-D-PS	14W	E26	120V	5000K	90	1400	40,000	Yes (Triac)	1/40	5.35"	90W	Yes
80252	14PAR38-NFL-LED-927-D-PS	14W	E26	120V	2700K	90	1400	40,000	Yes (Triac)	1/40	5.35"	90W	Yes
80253	14PAR38-NFL-LED-930-D-PS	14W	E26	120V	3000K	90	1400	40,000	Yes (Triac)	1/40	5.35"	90W	Yes
80254	14PAR38-NFL-LED-940-D-PS	14W	E26	120V	4000K	90	1400	40,000	Yes (Triac)	1/40	5.35"	90W	Yes
80255	14PAR38-NFL-LED-950-D-PS	14W	E26	120V	5000K	90	1400	40,000	Yes (Triac)	1/40	5.35"	90W	Yes
80256	14PAR38-FL-LED-927-D-BLK-PS	14W	E26	120V	2700K	90	1400	40,000	Yes (Triac)	1/40	5.35"	90W	Yes
80257	14PAR38-FL-LED-930-D-BLK-PS	14W	E26	120V	3000K	90	1400	40,000	Yes (Triac)	1/40	5.35"	90W	Yes
80258	14PAR38-FL-LED-940-D-BLK-PS	14W	E26	120V	4000K	90	1400	40,000	Yes (Triac)	1/40	5.35"	90W	Yes
80259	14PAR38-FL-LED-950-D-BLK-PS	14W	E26	120V	5000K	90	1400	40,000	Yes (Triac)	1/40	5.35"	90W	Yes

SPEC SHEET AVAILABLE HERE.

ProLED MR11



Product #	Product Code	Description	Wattage	Base	Voltage	Color Temp.	CRI	Lumens	CBCP	Useful Life ¹	Dimmable ²	Pkg. Qty.	Beam Spread	MOL	Eq. Wattage	ENERGY STAR [®]
81093	MR11FTD/827/LED	Flood	3W	GU4	10-18V	2700K	82	230	420	40,000	Yes	1/10	30°	1.42"	20W	No
81094	MR11FTD/827/BA15D/LED	Flood	3W	BA15d	10-15V	2700K	82	230	420	40,000	Yes	1/10	30°	1.42"	20W	No
81095	MR11FTD/850/LED	Flood	3W	GU4	10-18V	2700K	82	250	500	40,000	Yes	1/10	30°	1.42"	20W	No
81096	MR11FTC/827/LED	Narrow Flood	4.5W	GU4	10-18V	2700K	82	230	600	40,000	Yes	1/10	22°	1.42"	20W	No

Use on incompatible systems may shorten lamp life. Acceptable for use in sealed metal landscape luminaires when protected from the elements. May not be compatible with all electronic transformers. Magnetic transformers are recommended for Dimmable applications. Not for use in enclosed luminaires. Lamps should be tested in the application for compatibility prior to full installations on circuits using such devices.

SPEC SHEET AVAILABLE HERE.

ProLED Outdoor PAR36



Product #	Product Code	Description	Wattage	Base	Voltage	Color Temp.	CRI	Lumens	CBCP	Useful Life ¹	Dimmable ²	Pkg. Qty.	Beam Spread	MOL	Eq. Wattage	ENERGY STAR [®]
81074	PAR36WFL4/827/IP67/1LED	Wide Flood	4.5W	MP Term	10-15V	2700K	82	300	700	40,000	Yes	1/6	32°	2.40"	20W	No
81075	PAR36WFL6/827/IP67/LED	Wide Flood	6.5W	MP Term	10-15V	2700K	82	450	1100	40,000	Yes	1/6	32°	2.40"	35W	No
81076	PAR36WFL12/827/IP67/LED	Wide Flood	12.5W	MP Term	10-15V	2700K	82	800	2000	40,000	Yes	1/6	32°	2.40"	50W	No

SPEC SHEET AVAILABLE HERE.

ProLED PAR36/AR111 Indoor



Product #	Product Code	Description	Wattage	Base	Voltage	Color Temp.	CRI	Lumens	CBCP	Useful Life ¹	Dimmable ²	Pkg. Qty.	Beam Spread	MOL	Eq. Wattage	ENERGY STAR ³
81097	PAR36FL11/827/LED	Flood	11.5W	MP Term	12V	2700K	82	870	2000	40,000	Yes	1/6	32°	1.97"	50W	No
80863	PAR36FL17/827/LED	Flood	17W	MP Term	12V	2700K	82	1,000	2300	40,000	Yes	1/6	32°	1.97"	75W	No

Not for use in enclosed luminaires. May not be compatible with all electronic transformers. Rated for indoor use only

SPEC SHEET AVAILABLE HERE.

Linear LED Plug-In Series



Product #	Product Code	Wattage	Base	Voltage	Color Temp.	CRI	Lumens	Useful Life ¹	Dimmable ²	Pkg. Qty.	MOL	Eq. Wattage	DLC Qualified ³
82352	PLL13-830-DIR-LED	13W	2G11	120-277V	3000K	>80	2,050	50,000	No	25	21.8"	40W	Yes
82353	PLL13-835-DIR-LED	13W	2G11	120-277V	3500K	>80	2,050	50,000	No	25	21.8"	40W	Yes
82354	PLL13-840-DIR-LED	13W	2G11	120-277V	4000K	82	2,100	50,000	No	25	21.8"	40W	Yes
82349	PLL17-830-BYP-LED	17W	2G11	120-277V	3000K	>80	2,050	50,000	No	25	21.8"	40W	Yes
82350	PLL17-835-BYP-LED	17W	2G11	120-277V	3500K	82	2,150	50,000	No	25	21.8"	40W	Yes
82351	PLL17-840-BYP-LED	17W	2G11	120-277V	4000K	>80	2,200	50,000	No	25	21.8"	40W	Yes

SPEC SHEET AVAILABLE HERE.

ProLED Plug In Series



Product #	Product Code	Wattage	Base	Voltage	Color Temp.	CRI	Lumens	Useful Life ¹	Dimmable ²	Pkg. Qty.	MOL	Eq. Wattage	DLC Qualified ³
82150	PLT15H-835-BCO-4P-LED-D	14.5W	G24q	120-277V	3500K	≥80	1,800	50,000	Yes	24	6.65"	-	Yes
82151	PLT15H-840-BCO-4P-LED-D	14.5W	G24q	120-277V	4000K	≥80	1,800	50,000	Yes	24	6.65"	-	Yes
82152	PLT15H-850-BCO-4P-LED-D	14.5W	G24q	120-277V	5000K	≥80	1,800	50,000	Yes	24	6.65"	-	Yes
82153	PLT17V-835-BCO-4P-LED-D	17W	G24q	120-277V	3500K	≥80	1,900	50,000	Yes	24	6.40"	-	Yes
82154	PLT17V-840-BCO-4P-LED-D	17W	G24q	120-277V	4000K	≥80	1,950	50,000	Yes	24	6.40"	-	Yes
82155	PLT17V-850-BCO-4P-LED-D	17W	G24q	120-277V	5000K	≥80	2,000	50,000	Yes	24	6.40"	-	Yes
82156	PLT16H-835-BYP-2P-LED	15.5W	G24d	120-277V	3500K	≥80	1,800	50,000	No	24	6.65"	-	No
82157	PLT16H-840-BYP-2P-LED	15.5W	G24d	120-277V	4000K	≥80	1,800	50,000	No	24	6.65"	-	No
82158	PLT16H-850-BYP-2P-LED	15.5W	G24d	120-277V	5000K	≥80	1,800	50,000	No	24	6.65"	-	No
82159	PLT17V-835-BYP-2P-LED	16.5W	G24d	120-277V	3500K	≥80	1,850	50,000	No	24	6.40"	-	No
82160	PLT17V-840-BYP-2P-LED	16.5W	G24d	120-277V	4000K	≥80	1,850	50,000	No	24	6.40"	-	No
82161	PLT17V-850-BYP-2P-LED	16.5W	G24d	120-277V	5000K	≥80	1,850	50,000	No	24	6.40"	-	No



[SPEC SHEET AVAILABLE HERE.](#)

ProLED PL Bypass Series



Product #	Product Code	Wattage	Base	Voltage	Color Temp.	CRI	Lumens	Useful Life ¹	Dimmable ²	Pkg. Qty.	MOL	Eq. Wattage	DLC Qualified ³
Vertical													
81141	PL10V/835/BYP/LED	10W	G24q/GX24q/G24d/GX24d	120-277V	3500K	82	1,000	50,000	No	1/10	4.60"	26W	No
81142	PL10V/841/BYP/LED	10W	G24q/GX24q/G24d/GX24d	120-277V	4100K	82	1,000	50,000	No	1/10	4.60"	26W	No
81143	PL10V/850/BYP/LED	10W	G24q/GX24q/G24d/GX24d	120-277V	5000K	82	1,000	50,000	No	1/10	4.60"	26W	No
Horizontal													
81144	PL10H/835/BYP/LED	10W	G24q/GX24q/G24d/GX24d	120-277V	3500K	82	1,000	50,000	No	1/10	5.20"	26W	No
81145	PL10H/841/BYP/LED	10W	G24q/GX24q/G24d/GX24d	120-277V	4100K	82	1,000	50,000	No	1/10	5.20"	26W	No
81146	PL10H/850/BYP/LED	10W	G24q/GX24q/G24d/GX24d	120-277V	5000K	82	1,000	50,000	No	1/10	5.20"	26W	No

Must be operated with an ambient luminaire temperature between -4°F(-20°C) and 122°F(50°C).

[SPEC SHEET AVAILABLE HERE.](#)

ProLED Plugin Series



Product #	Product Code	Wattage	Base	Voltage	Color Temp.	CRI	Lumens	Useful Life ¹	Dimmable ²	Pkg. Qty.	MOL	Eq. Wattage	DLC Qualified ³
82144	PL100-835-HYBE-4P-LED-D	9.5W	G24q	120-277V	3500K	≥80	1,250	50,000	Yes	24	6.87"	26W	Yes
82145	PL100-840-HYBE-4P-LED-D	9.5W	G24q	120-277V	4000K	≥80	1,250	50,000	Yes	24	6.87"	26W	Yes
82146	PL100-850-HYBE-4P-LED-D	9.5W	G24q	120-277V	5000K	≥80	1,250	50,000	Yes	24	6.87"	26W	Yes
82147	PL90-835-HYBM-2P-LED	9W	G24d	120-277V	3500K	≥80	1,250	50,000	No	24	6.26"	26W	Yes
82148	PL90-840-HYBM-2P-LED	9W	G24d	120-277V	4000K	≥80	1,250	50,000	No	24	6.26"	26W	Yes
82149	PL90-850-HYBM-2P-LED	9W	G24d	120-277V	5000K	≥80	1,250	50,000	No	24	6.26"	26W	Yes

[SPEC SHEET AVAILABLE HERE.](#)

ProLED PL Hybrid Series



Product #	Product Code	Wattage	Base	Voltage	Color Temp.	CRI	Lumens	Useful Life ¹	Dimmable ²	Pkg. Qty.	MOL	Eq. Wattage	DLC Qualified ³
81159	PL6H/827/HYB/LED	6W	GX23	120-277V	2700K	82	520	50,000	No	1/10	5.50"	13W	No
81160	PL6H/830/HYB/LED	6W	GX23	120-277V	3000K	82	520	50,000	No	1/10	5.50"	13W	No
81161	PL6H/835/HYB/LED	6W	GX23	120-277V	3500K	82	520	50,000	No	1/10	5.50"	13W	No
81162	PL6H/840/HYB/LED	6W	GX23	120-277V	4000K	82	520	50,000	No	1/10	5.50"	13W	No
81163	PL6H/850/HYB/LED	6W	GX23	120-277V	5000K	82	520	50,000	No	1/10	5.50"	13W	No

* Can be mounted vertical / works with or without ballast / ICAT Rated

[SPEC SHEET AVAILABLE HERE.](#)

ProLED Hybrid Plugin CCT Series



Product #	Product Code	Wattage	Base	Voltage	Color Temp.	CRI	Lumens	Useful Life ¹	Dimmable ²	Pkg. Qty.	MOL	Eq. Wattage	DLC Qualified ³
82162	PL9H-8CS-HYBM-2P-LED	8.5W	G24d	120-277V	3000K, 3500K, 4000K	≥80	960	50,000	No	24	5.12"	26W	No
82163	PL9V-8CS-HYBM-2P-LED	8.5W	G24d	120-277V	3000K, 3500K, 4000K	≥80	1100	50,000	No	24	6.40"	26W	No

* Can be mounted vertical / works with or without ballast / ICAT Rated

[SPEC SHEET AVAILABLE HERE.](#)

ProLED Decorative Chandelier

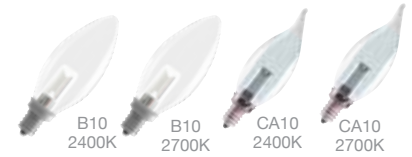

Product #	Product Code	Description	Wattage	Base	Voltage	Color Temp.	CRI	Lumens	Useful Life ¹	Dimmable ²	Pkg. Qty.	MOL	Eq. Wattage	ENERGY STAR [®]
B10														
80172	B10CL1/827/LED	Clear Torpedo	1W	E12	120V	2700K	82	25	25,000	Yes	1/25	3.77"	7.5W	No
CA10														
80174	CA10CL1/827/LED	Clear Flame Tip	1W	E12	120V	2700K	82	25	25,000	Yes	1/25	4.01"	7.5W	No

Not for use in enclosed luminaires.

[SPEC SHEET AVAILABLE HERE.](#)

ProLED G25 Series Globe



Product #	Product Code	Description	Wattage	Base	Voltage	Color Temp.	CRI	Lumens	Useful Life ¹	Dimmable ²	Pkg. Qty.	MOL	Eq. Wattage	ENERGY STAR [®]
80180	G25FR6/830/LED	Globe	6W	E26	120V	3000K	82	470	25,000	Yes	1/6	4.25"	40W	Yes

Use on incompatible systems may shorten lamp life

[SPEC SHEET AVAILABLE HERE.](#)

[SPEC SHEET AVAILABLE HERE.](#)

ProLED Filament LED Series



Product #	Product Code	Description	Wattage	Base	Voltage	Color Temp.	CRI	Lumens	Useful Life ¹	Dimmable ²	Pkg. Qty.	MOL	Eq. Wattage	ENERGY STAR [®]
B11														
85051	B11CL2/ANT/827/LED2	Clear Filament	2.5W	E12	120V	2700K	82	180	15,000	Yes	1/10	3.78"	25W	Yes
85053	B11CL4/ANT/830/LED2	Clear Filament	4.5W	E12	120V	3000K	82	350	15,000	Yes	1/10	3.78"	40W	Yes
85054	B11CL4/ANT/827/LED2	Clear Filament	3.8W	E12	120V	2700K	82	300	15,000	Yes	1/10	3.72"	40W	Yes
85055	B11CL4ANT/827/E26/LED2	Clear Filament	3.8W	E26	120V	2700K	82	300	15,000	Yes	1/10	3.78"	40W	Yes
85058	B11CL5ANT/827/LED2	Clear Filament	5.5W	E12	120V	2700K	82	500	15,000	Yes	1/10	3.72"	60W	No
85059	B11AMB5ANT/822/LED2	Amber Filament	5.5W	E12	120V	2200K	82	400	15,000	Yes	1/10	3.78"	60W	Yes
85060	B11CL5/ANT/830/LED2	Clear Filament	5.5W	E12	120V	3000K	82	500	15,000	Yes	1/10	3.72"	60W	Yes
85157	B11CL5ANT/827/E26/LED2	Clear Filament	5W	E26	120V	2700K	82	500	15,000	Yes	10/100	3.72"	40W	No
CA10														
85061	CA10CL2ANT/827/LED2	Clear Filament	2.5W	E12	120V	2700K	82	180	15,000	Yes	1/10	4.09"	25W	Yes
85065	CA10CL4ANT/827/LED2	Clear Filament	3.8W	E12	120V	2700K	82	300	15,000	Yes	1/10	3.72"	40W	Yes
85066	CA10CL4ANT/830/LED2	Clear Filament	4.5W	E12	120V	3000K	82	350	15,000	Yes	1/10	3.78"	40W	Yes
85082	CA10FR4ANT/827/LED2	Frosted Filament	3.8W	E12	120V	2700K	82	300	15,000	Yes	1/10	3.78"	40W	Yes
A15														
85035	A15CL5ANT/827/LED2	Clear Filament	5W	E26	120V	2700K	82	450	15,000	Yes	1/10	4.13"	40W	Yes
A19														
85037	A19CL5ANT/827/LED2	Clear Filament	5.5W	E26	120V	2700K	82	450	15,000	Yes	1/10	4.13"	40W	Yes
85038	A19AMB5ANT/820/LED2	Frosted Filament	5.5W	E26	120V	2000K	82	450	15,000	Yes	1/10	4.13"	40W	Yes
85039	A19CL9ANT/827/LED2	Clear Filament	9W	E26	120V	2700K	82	800	15,000	Yes	1/10	4.13"	60W	Yes
85040	A19FR9ANT/827/LED2	Frosted Filament	9W	E26	120V	2700K	82	800	15,000	Yes	1/10	4.13"	60W	Yes
85144	9A19-CL-FLED3-930-D	Clear Filament	9W	E26	120	3000K	90	800	15,000	Yes	1 / 60	4.13	60W	Yes
85148	9A19-CL-FLED3-927-D	Clear Filament	9W	E26	120	2700K	90	800	15,000	Yes	1 / 60	4.13	60W	Yes

● Indicates New performance filament product and spec sheet added

** Wet location listed. ENERGY STAR[®] mandates that lamps may only be listed at 25,000 hour life with 3,000 hour actual life test data, 6,000 hour LM80 data and in-situ temperature measurements. Upon completion of full lifetime testing, ProLED ENERGY STAR[®] listed lamps will be listed at their full lifetime.

Continue to next page for additional product information



ProLED Filament LED Series

Product #	Product Code	Description	Wattage	Base	Voltage	Color Temp.	CRI	Lumens	Useful Life ¹	Dimmable ²	Pkg. Qty.	MOL	Eq. Wattage	ENERGY STAR [®]
S14														
81139**	S14CL2ANT/827/LED	Clear Filament	2W	E26	120V	2700K	82	200	15,000	No	25/100	3.46"	25W	Yes
81140**	S14AMB2ANT/822/LED	Amber Filament	2W	E26	120V	2200K	82	160	15,000	No	25/100	3.46"	25W	Yes
82139**	S14CL2ANT/827/LED2	Clear Filament	2W	E26	120V	2700K	82	200	15,000	Yes	25/100	3.46"	25W	No
82140**	S14AMB2ANT/822/LED2	Amber Filament	2W	E26	120V	2200K	82	160	15,000	Yes	25/100	3.46"	25W	No
G16.5														
85071	G16.5CL4ANT/827/LED2	Clear Filament	4.5W	E12	120V	2700K	82	350	15,000	Yes	1/10	4.13"	40W	Yes
G25														
85047	G25CL5ANT/827/LED2	Clear Filament	5.5W	E26	120V	2700K	82	500	15,000	Yes	1/10	4.60"	60W	Yes
85048	G25FR5ANT/827/LED2	Frosted Filament	5.5W	E26	120V	2700K	82	500	15,000	Yes	1/10	4.60"	60W	Yes
85049	G25CL5ANT/830/LED2	Clear Filament	5.5W	E26	120V	3000K	82	500	15,000	Yes	1/10	4.60"	60W	Yes
85172	G25CL8ANT/827/LED2	Clear Filament	8W	E26	120V	2700K	82	800	15,000	Yes	10/60	4.52"	60W	Yes
ST19														
85043	ST19CL5ANT/827/LED2	Clear Filament	5.5W	E26	120V	2700K	82	500	15,000	Yes	1/10	5.79"	60W	Yes
85044	ST19AMB5ANT/822/LED2	Amber Filament	5.5W	E26	120V	2200K	82	400	15,000	Yes	1/10	5.79"	40W	Yes
85146	ST19AMB8ANT/822/LED2	Amber Filament	8W	E26	120V	2200K	82	650	15,000	Yes	10/60	5.79"	40W	Yes
85143	9ST19-CL-FLED3-930-D	Clear Filament	9W	E26	120V	3000K	90	800	15,000	Yes	1 / 60	5.79"	60W	Yes
85147	9ST19-CL-FLED3-927-D	Clear Filament	9W	E26	120V	2700K	90	800	15,000	Yes	1 / 60	5.79"	60W	Yes
T10														
85074	T10CL4ANT/827/LED2	Clear Filament	4.5W	E26	120V	2700K	82	350	15,000	Yes	1/10	7.44"	40W	No
T14														
85073	T14CL4ANT/827/LED2	Clear Filament	4.5W	E26	120V	2700K	82	450	15,000	Yes	1/10	3.46"	25W	Yes

● Indicates new products added

SPEC SHEET AVAILABLE HERE.

ProLED B11 Chandelier



Cream 3W



Cream 5W Med.

Product #	Product Code	Description	Wattage	Base	Voltage	Color Temp.	CRI	Lumens	Useful Life ¹	Dimmable ²	Pkg. Qty.	MOL	Eq. Wattage	ENERGY STAR [®]
80094	B11CL3/827/LED	Cream Finish	3W	E12	120V	2700K	82	180	25,000	Yes	1/10	3.78"	25W	No
80789	B11CL3/827/BR/LED	Brass Finish	3W	E12	120V	2700K	82	180	25,000	Yes	1/10	3.78"	25W	No
80790	B11CL3/827/CHR/LED	Chrome Finish	3W	E12	120V	2700K	82	180	25,000	Yes	1/10	3.78"	25W	No
80185	B11CL3/830/LED	Cream Finish	3W	E12	120V	3000K	82	180	25,000	Yes	1/10	3.78"	25W	No
80820	B11CL5/827/LED	Cream Finish	4.5W	E12	120V	2700K	82	300	25,000	Yes	1/10	3.78"	40W	Yes
80168	B11CL5/827/E26/LED	Cream Finish	4.5W	E26	120V	2700K	82	300	25,000	Yes	1/10	3.78"	40W	Yes
80183	B11CL5/830/E26/LED	Cream Finish	4.5W	E26	120V	3000K	82	300	25,000	Yes	1/10	3.78"	40W	Yes
80184	B11CL5/830/LED	Cream Finish	4.5W	E12	120V	3000K	82	300	25,000	Yes	1/10	3.78"	40W	Yes

SPEC SHEET AVAILABLE HERE.

ProLED Sign Lamp Series



Product #	Product Code	Description	Wattage	Base	Voltage	Color Temp.	CRI	Lumens	Useful Life ¹	Dimmable ²	Pkg Qty.	MOL	Eq. Wattage	ENERGY STAR [®]
S11														
80525	S11CL1C/827/INT/LED	Clear, IP65 Rated	1.2W	E17	120V	2700K	82	35	40,000	Yes	1/25	2.24"	11W	No
80524	S11CL1C/827/LED	Clear, IP65 Rated	1.2W	E26	120V	2700K	82	35	40,000	Yes	1/25	2.24"	11W	No
80526	S11WH1C/LED	White, IP65 Rated	1.2W	E26	120V	White	-	-	40,000	Yes	1/25	2.24"	11W	No
S14														
80522	S14CL1C/827/LED	Clear, IP65 Rated	1.4W	E26	120V	2700K	82	35	40,000	Yes	1/25	3.35"	11W	No
80517	S14RED1C/LED	Red, IP65 Rated	1.4W	E26	120V	Red	-	-	40,000	Yes	1/25	3.35"	11W	No
80518	S14BLU1C/LED	Blue, IP65 Rated	1.4W	E26	120V	Blue	-	-	40,000	Yes	1/25	3.35"	11W	No
80519	S14GRN1C/LED	Green, IP65 Rated	1.4W	E26	120V	Green	-	-	40,000	Yes	1/25	3.35"	11W	No
80520	S14YEL1C/LED	Yellow, IP65 Rated	1.4W	E26	120V	Yellow	-	-	40,000	Yes	1/25	3.35"	11W	No
80521	S14WH1C/LED	White, IP65 Rated	1.4W	E26	120V	White	-	-	40,000	Yes	1/25	3.35"	11W	No
80523	S14ORG1C/LED	Orange, IP65 Rated	1.4W	E26	120V	Orange	-	-	40,000	Yes	1/25	3.35"	11W	No

Not for use in enclosed luminaires.

SPEC SHEET AVAILABLE HERE.

ProLED Elevator Lamp



Product #	Product Code	Description	Wattage	Base	Voltage	Color Temp.	CRI	Lumens	CBCP	Useful Life ¹	Dimmable ²	Pkg. Qty.	Beam Spread	MOL	Eq. Wattage	ENERGY STAR [®]
80756	GBF/3WW/LED	Flood	2.6W	BA15d	10-18V	2700K	82	410	145	40,000	No	1/10	31°	2.52"	20W	No
80701	1383/3WW/LED	Flood	2.6W	BA15s	10-18V	2700K	82	410	145	40,000	No	1/10	31°	2.52"	20W	No

SPEC SHEET AVAILABLE HERE.

ProLED MR16 GU10



Product #	Product Code	Description	Wattage	Base	Voltage	Color Temp.	CRI	Lumens	CBCP	Useful Life ¹	Dimmable ²	Pkg. Qty.	Beam Spread	MOL	Eq. Wattage	ENERGY STAR [®]
80529	MR16FL4/827/GU10/LED	Flood	4.5W	GU10	120V	2700K	82	360	525	25,000	Yes	1/10	40°	2.70"	35W	No
80887	MR16FL4/830/GU10/LED	Flood	4.5W	GU10	120V	3000K	82	370	525	25,000	Yes	1/10	40°	2.17"	35W	Yes
80531	MR16FL4/840/GU10/LED	Flood	4.5W	GU10	120V	4000K	82	360	525	25,000	Yes	1/10	40°	2.70"	35W	No
80533	MR16FL4/850/GU10/LED	Flood	4.5W	GU10	120V	5000K	82	360	525	25,000	Yes	1/10	40°	2.70"	35W	No
80528	MR16FL6/827/GU10/LED	Flood	6.5W	GU10	120V	2700K	82	500	730	25,000	Yes	1/10	40°	2.17"	50W	No
80888	MR16FL6/830/GU10/LED	Flood	6.5W	GU10	120V	3000K	82	520	730	25,000	Yes	1/10	40°	2.17"	50W	Yes
80530	MR16FL6/840/GU10/LED	Flood	6.5W	GU10	120V	4000K	82	500	730	25,000	Yes	1/10	40°	2.17"	50W	No
80532	MR16FL6/850/GU10/LED	Flood	6.5W	GU10	120V	5000K	82	500	730	25,000	Yes	1/10	40°	2.17"	50W	Yes



[SPEC SHEET AVAILABLE HERE.](#)

ProLED MR16



Product #	Product Code	Description	Wattage	Base	Voltage	Color Temp.	CRI	Lumens	CBCP	Useful Life ¹	Dimmable ²	Pkg. Qty.	Beam Spread	MOL Eq. Wattage	ENERGY STAR [®]	
81055	MR16NFL10/827/LED	Narrow Flood	2.5W	GU5.3	10-18V	2700K	82	200	800	40,000	Yes	1/10	20°	1.97"	10W	No
81079	MR16NFL10/830/LED	Narrow Flood	2.5W	GU5.3	10-18V	3000K	82	210	830	40,000	Yes	1/10	20°	1.97"	10W	No
81056	MR16FL10/827/LED	Flood	2.5W	GU5.3	10-18V	2700K	82	200	300	40,000	Yes	1/10	40°	1.97"	10W	No
81057	MR16WFL10/827/LED	Wide Flood	2.5W	GU5.3	10-18V	2700K	82	200	200	40,000	Yes	1/10	60°	1.97"	10W	No
81080	MR16WFL10/830/LED	Wide Flood	2.5W	GU5.3	10-18V	3000K	82	210	220	40,000	Yes	1/10	60°	1.97"	10W	No
81059	MR16BBF/827/LED	Narrow Flood	4W	GU5.3	10-18V	2700K	82	270	900	40,000	Yes	1/10	20°	1.97"	20W	Yes
81081	MR16BBF/830/LED	Narrow Flood	4W	GU5.3	10-18V	3000K	82	280	1100	40,000	Yes	1/10	20°	1.97"	20W	Yes
81060	MR16BAB/827/LED	Flood	4W	GU5.3	10-18V	2700K	82	270	440	40,000	Yes	1/10	40°	1.97"	20W	Yes
81062	MR16BAB/830/LED	Flood	4W	GU5.3	10-18V	3000K	82	280	500	40,000	Yes	1/10	40°	1.97"	20W	Yes
81063	MR16BAB/850/LED	Flood	4W	GU5.3	10-18V	5000K	82	310	530	40,000	Yes	1/10	40°	1.97"	20W	Yes
81061	MR16WFL20/827/LED	Wide Flood	4W	GU5.3	10-18V	2700K	82	270	210	40,000	Yes	1/10	60°	1.97"	20W	No
81082	MR16WFL20/830/LED	Wide Flood	4W	GU5.3	10-18V	3000K	82	280	230	40,000	Yes	1/10	60°	1.97"	20W	No
81064	MR16FRA/827/LED	Narrow Flood	4.5W	GU5.3	10-18V	2700K	82	380	1700	40,000	Yes	1/10	20°	1.97"	35W	Yes
81083	MR16FRA/830/LED	Narrow Flood	4.5W	GU5.3	10-18V	3000K	82	390	1800	40,000	Yes	1/10	20°	1.97"	35W	Yes
81065	MR16FMW/827/LED	Flood	4.5W	GU5.3	10-18V	2700K	82	380	600	40,000	Yes	1/10	40°	1.97"	35W	Yes
81067	MR16FMW/830/LED	Flood	4.5W	GU5.3	10-18V	3000K	82	390	650	40,000	Yes	1/10	40°	1.97"	35W	Yes
81068	MR16FMW/850/LED	Flood	4.5W	GU5.3	10-18V	5000K	82	430	700	40,000	Yes	1/10	40°	1.97"	35W	Yes
81066	MR16WFL35/827/LED	Wide Flood	4.5W	GU5.3	10-18V	2700K	82	380	300	40,000	Yes	1/10	60°	1.97"	35W	No
81084	MR16WFL35/830/LED	Wide Flood	4.5W	GU5.3	10-18V	3000K	82	390	320	40,000	Yes	1/10	60°	1.97"	35W	No
81069	MR16EXZ/827/LED	Narrow Flood	8W	GU5.3	10-18V	2700K	82	590	2700	40,000	Yes	1/10	20°	1.97"	50W	No
81085	MR16EXZ/830/LED	Narrow Flood	8W	GU5.3	10-18V	3000K	82	600	2800	40,000	Yes	1/10	20°	1.97"	50W	No
81070	MR16EXN/827/LED	Flood	8W	GU5.3	10-18V	2700K	82	590	1100	40,000	Yes	1/10	40°	1.97"	50W	No
81072	MR16EXN/830/LED	Flood	8W	GU5.3	10-18V	3000K	82	600	1200	40,000	Yes	1/10	40°	1.97"	50W	No
81073	MR16EXN/850/LED	Flood	8W	GU5.3	10-18V	5000K	82	660	1400	40,000	Yes	1/10	40°	1.97"	50W	No
81071	MR16FNV/827/LED	Wide Flood	8W	GU5.3	10-18V	2700K	82	590	500	40,000	Yes	1/10	60°	1.97"	50W	No
81086	MR16FNV/830/LED	Wide Flood	8W	GU5.3	10-18V	3000K	82	600	520	40,000	Yes	1/10	60°	1.97"	50W	No

Acceptable for use in sealed metal landscape luminaires when protected from the elements.

SPEC SHEET AVAILABLE HERE.

ProLED Commercial MR16/MR11



Product #	Product Code	Description	Wattage	Base	Voltage	Color Temp.	CRI	Lumens	CBCP	Useful Life ¹	Dimmable ²	Pkg. Qty.	Beam Spread	MOL	Eq. Wattage	ENERGY STAR [®]
MR11																
80996	MR11NFL3/827/LED	Narrow Flood	3W	GU4	12V	2700K	82	210	700	25,000	No	1/10	20°	1.48"	20W	No
80997	MR11NFL3/830/LED	Narrow Flood	3W	GU4	12V	3000K	82	210	700	25,000	No	1/10	20°	1.48"	20W	No
80998	MR11NFL3/840/LED	Narrow Flood	3W	GU4	12V	4000K	82	210	700	25,000	No	1/10	20°	1.48"	20W	No
80999	MR11NFL3/850/LED	Narrow Flood	3W	GU4	12V	5000K	82	210	700	25,000	No	1/10	20°	1.48"	20W	No
MR16																
80534	MR16FL4/827/LED2	Flood	4.5W	GU5.3	12V	2700K	82	360	730	25,000	Yes	1/10	40°	1.77"	35W	No
80535	MR16FL4/830/LED2	Flood	4.5W	GU5.3	12V	3000K	82	370	750	25,000	Yes	1/10	40°	1.77"	35W	No
80536	MR16FL4/850/LED2	Flood	4.5W	GU5.3	12V	5000K	82	400	810	25,000	Yes	1/10	40°	1.77"	35W	No
80537	MR16FL6/827/LED2	Flood	6.5W	GU5.3	12V	2700K	82	500	1100	25,000	Yes	1/10	40°	1.77"	50W	Yes
80538	MR16FL6/830/LED2	Flood	6.5W	GU5.3	12V	3000K	82	500	730	25,000	Yes	1/10	40°	1.77"	50W	Yes
80539	MR16FL6/850/LED2	Flood	6.5W	GU5.3	12V	5000K	82	500	1190	25,000	Yes	1/10	40°	1.77"	50W	Yes
80540	MR16NFL6/830/LED2	Narrow Flood	6.5W	GU5.3	12V	3000K	82	520	2420	25,000	Yes	1/10	20°	1.77"	50W	Yes

Acceptable for use in sealed metal landscape luminaires when protected from the elements.

SPEC SHEET AVAILABLE HERE.

ProLED MR16 Black



Product #	Product Code	Description	Wattage	Base	Voltage	Color Temp.	CRI	Lumens	Useful Life ¹	Dimmable ²	Pkg. Qty.	Beam Spread	MOL	Eq. Wattage	ENERGY STAR [®]
81103	MR16NFL4/827/LED	Narrow Flood, Black	4W	GU5.3	10-15V	2700K	82	250	30,000	Yes	1/10	20°	1.97"	20W	No
81098	MR16FL4/827/LED	Flood, Black	4W	GU5.3	10-15V	2700K	82	250	30,000	Yes	1/10	40°	1.97"	20W	No
81099	MR16WFL4/827/LED	Wide Flood, Black	4W	GU5.3	10-15V	2700K	82	250	30,000	Yes	1/10	60°	1.97"	20W	No
82094	MR16NFL4.5/827/LED	Narrow Flood, Black	4.5W	GU5.3	10-15V	2700K	82	390	30,000	Yes	1/10	20°	1.97"	35W	No
82095	MR16FL4.5/827/LED	Narrow Flood, Black	4.5W	GU5.3	10-15V	2700K	82	390	30,000	Yes	1/10	40°	1.97"	35W	No

Use on incompatible systems may shorten lamp life. Acceptable for use in sealed metal landscape luminaires when protected from the elements



SPEC SHEET AVAILABLE HERE.



ProLED IP Rated LED JC Series

Product #	Product Code	Description	Wattage	Base	Voltage	Color Temp.	CRI	Lumens	Useful Life ¹	Dimmable ²	Pkg. Qty.	MOL	Eq. Wattage	ENERGY STAR [®]
JC2S														
81091	JC2S/827/LED2	IP65 Rated	1.4W	G4	10-15V	2700K	82	140	40,000	No	1/10	0.98"	20W	No
81092	JC2S/830/LED2	IP65 Rated	1.4W	G4	10-15V	3000K	82	150	40,000	No	1/10	0.98"	20W	No
JC2														
81109	JC2/827/LED2	Omnidirectional, IP65 Rated	2.3W	G4	10-15V	2700K	82	250	40,000	No	1/10	1.57"	20W	No
81108	JC20/2WW/LED2	Omnidirectional, IP65 Rated	2.3W	G4	10-15V	3000K	82	250	40,000	No	1/10	1.57"	20W	No
JC20														
81100	JC20/2WW/BA15S/LED2	IP65 Rated	2.3W	BA15s	10-15V	3000K	82	250	40,000	No	1/10	2.00"	20W	No
81102	912/1WW/LED2	IP65 Rated	1.2W	Wedge	10-15V	3000K	82	120	40,000	No	1/10	1.51"	10W	No
81101	3155/2WW/LED2	IP65 Rated	2.3W	Wedge	10-15V	3000K	82	250	40,000	No	1/10	1.67"	20W	No

SPEC SHEET AVAILABLE HERE.



ProLED Omnidirectional IP65 JC Lamps

Product #	Product Code	Description	Wattage	Base	Voltage	Color Temp.	CRI	Lumens	Useful Life ¹	Dimmable ²	Pkg. Qty.	MOL	Eq. Wattage	ENERGY STAR [®]
81998	JC1/830/OMNI/IP65/LED	IP65 Rated	1.2W	G4	10-15V	3000K	82	110	15,000	No	1/10	1.18"	10W	No
81999	JC2/830/OMNI/IP65/LED	IP65 Rated	1.5W	G4	10-15V	3000K	82	200	15,000	No	1/10	1.46"	20W	No
81996	JC3/830/OMNI/IP65/LED	IP65 Rated	2W	G4	10-15V	3000K	82	300	15,000	No	1/10	1.61"	20W	No

May not be compatible with electronic transformers. Suitable for use in sealed metal landscape luminaires. IP65 rated lamps are rated for use outdoors where exposed directly to water from rain or irrigation. This lamp is not for submersible use.

[SPEC SHEET AVAILABLE HERE.](#)

ProLED Traditional JC Series



Product #	Product Code	Description	Wattage	Base	Voltage	Color Temp.	CRI	Lumens	Useful Life ¹	Dimmable ²	Pkg. Qty.	MOL	Eq. Wattage	ENERGY STAR [®]
Mini Wedge														
80791	912/1WW/LED	Omnidirectional	1W	Wedge	10-18V	3000K	82	75	20,000	Yes	1/50	1.18"	10W	No
JC10														
80692	JC10/1WW/BA15S/LED	Omnidirectional	1.5W	BA15s	10-24V	3000K	82	150	30,000	Yes	1/40	1.70"	10W	No
80693	JC10/1WW/LED	Omnidirectional	1.5W	G4	10-24V	3000K	82	150	30,000	No	1/10	1.21"	10W	No
JC20														
80691	JC20/2WW/BA15S/LED	Omnidirectional	2.4W	BA15s	10-24V	3000K	82	250	30,000	Yes	1/40	2.01"	20W	No
80690	JC20/2WW/LED	Omnidirectional	2.4W	G4	10-24V	3000K	82	250	30,000	No	1/40	1.81"	20W	No
80815	JC20/2NW/LED	Omnidirectional	2.4W	G4	10-24V	5000K	82	260	30,000	No	1/10	1.81"	20W	No
JC35														
80830	JC35/4WW/LED	Omnidirectional	4.5W	GY6.35	10-18V	3000K	82	450	30,000	No	1/30	1.71"	35W	No
JC50														
81997	JC50/5WW/LED	Omnidirectional	5.5W	GY6.35	10-18V	3000K	82	550	30,000	No	1/30	1.71"	50W	No

May not be compatible with all electronic transformers.
Not for use in enclosed luminaires. Suitable for use in sealed metal landscape luminaires; traditional JC lamps require protection from elements.

[SPEC SHEET AVAILABLE HERE.](#)

ProLED Traditional LED Series



Product #	Product Code	Description	Wattage	Base	Voltage	Color Temp.	CRI	Lumens	Useful Life ¹	Dimmable ²	Pkg. Qty.	MOL	Eq. Wattage	ENERGY STAR [®]
81078	JC3VWFL/827/LED	Very Wide Flood	3.3W	G4	12V	2700K	82	200	25,000	No	1/10	1.38"	20W	No

May not be compatible with all electronic transformers.
Not for use in enclosed luminaires. Suitable for use in sealed metal landscape luminaires; traditional JC lamps require protection from elements.

¹ Useful Life is defined as the point in time at which the LED will maintain at least 70% of its initial lumens. The LED will continue to operate past this point at decreased light levels.

² May not be compatible with all Dimming systems, Dimming performance may vary by system. Please check www.halcolighting.com for up-to-date dimmer compatibility information. Use on incompatible systems may shorten lamp life.

³ To view our DLC qualified products, please consult the DLC Qualified Products List at www.designlights.org/qpl.

Traditional Lamps

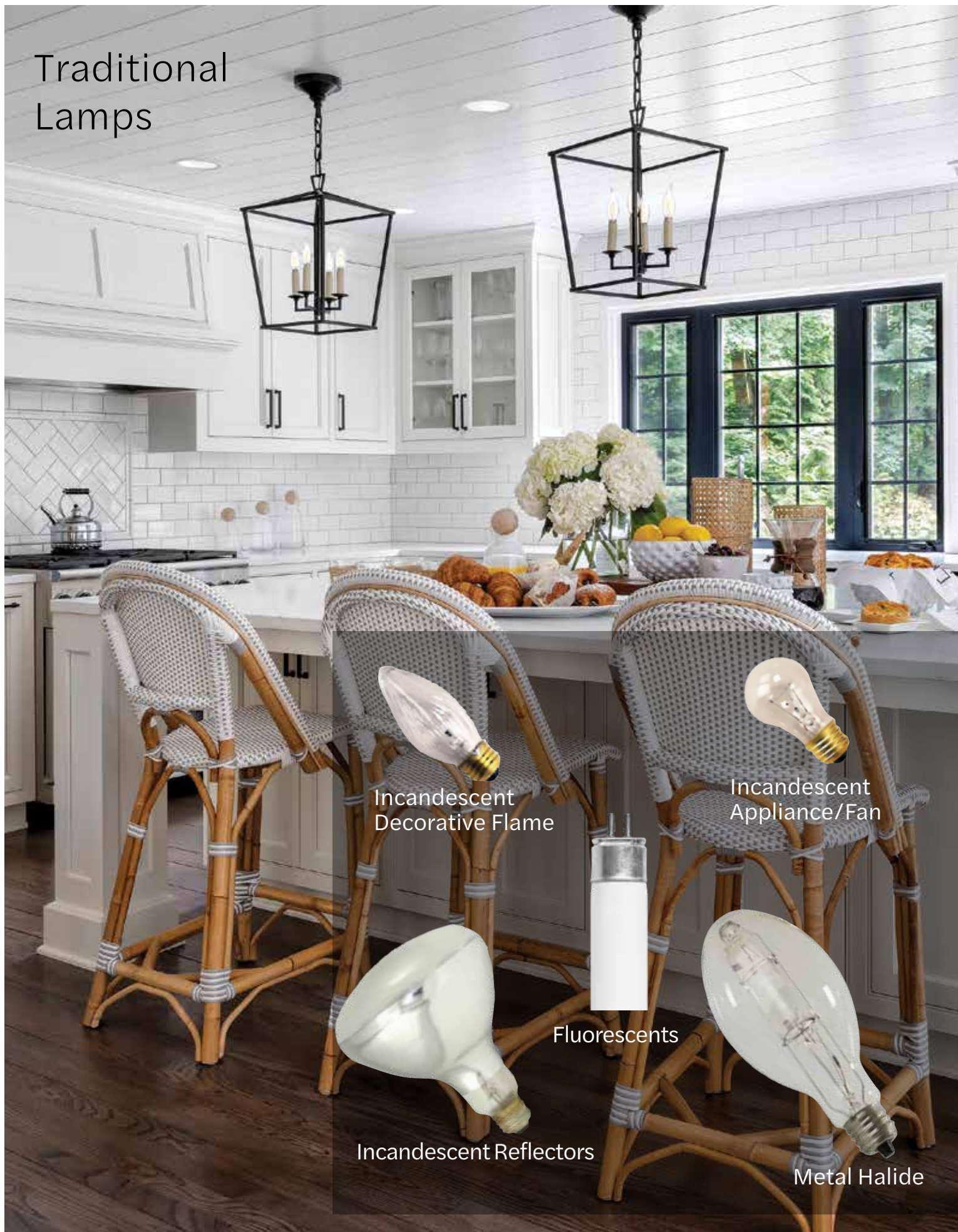

Incandescent
Decorative Flame

Incandescent
Appliance/Fan

Fluorescents

Incandescent Reflectors

Metal Halide



SPEC SHEET AVAILABLE HERE.

Compact Fluorescent Lamps Spiral



Product #	Product Code	Description	Wattage	Base	Voltage	Color Temp.	CRI	Lumens	Useful Life	Dimmable	Pkg. Qty	MOL	Eq. Wattage
CFL GU24 Base Spiral T2													
46506	CFL13/27/GU24	CFL GU24 Base Spirals	13W	GU24	120V	2700K	82	800	10,000	No	10	3.63	60W
46525	CFL13/35/GU24	CFL GU24 Base Spirals	13W	GU24	120V	3500K	82	800	10,000	No	10	3.63	60W
46526	CFL13/41/GU24	CFL GU24 Base Spirals	13W	GU24	120V	4100K	82	800	10,000	No	10	3.63	60W
46527	CFL13/50/GU24	CFL GU24 Base Spirals	13W	GU24	120V	5000K	82	800	10,000	No	10	3.63	60W
46512	CFL18/27/GU24	CFL GU24 Base Spirals	18W	GU24	120V	2700K	82	1200	10,000	No	10	3.9	75W
46520	CFL18/41/GU24	CFL GU24 Base Spirals	18W	GU24	120V	4100K	82	1200	10,000	No	10	3.9	75W
46518	CFL23/27/GU24	CFL GU24 Base Spirals	23W	GU24	120V	2700K	82	1600	10,000	No	10	4.41	100W
46522	CFL23/35/GU24	CFL GU24 Base Spirals	23W	GU24	120V	3500K	82	1600	10,000	No	10	4.41	100W
46523	CFL23/41/GU24	CFL GU24 Base Spirals	23W	GU24	120V	4100K	82	1600	10,000	No	10	4.41	100W
46524	CFL23/50/GU24	CFL GU24 Base Spirals	23W	GU24	120V	5000K	82	1600	10,000	No	10	4.41	100W
46528	CFL26/27/GU24	CFL GU24 Base Spirals	26W	GU24	120V	2700K	82	1750	10,000	No	10	5.2	100W
46529	CFL26/41/GU24	CFL GU24 Base Spirals	26W	GU24	120V	4100K	82	1750	10,000	No	10	5.2	100W
CFL Base Spiral E26													
45054	CFL13/35/T2	CFL T2 Spirals	13W	Medium (E26)	120V	3500K	82	750	8,000	No	10	4.19	60W
CFL Base Spiral E12													
45059	CFL13/50/T2/E12	CFL T2 Spirals	13W	Candelabra (E12)	120V	5000K	82	850	10,000	No	10	4.19	60W
CFL Base Spiral T2													
• 45065	CFL18/41/T2	CFL T2 Spirals	18W	Medium (E26)	120V	4100K	82	1080	8,000	No	10	4.56	75W
• 45066	CFL18/50/T2	CFL T2 Spirals	18W	Medium (E26)	120V	5000K	82	1080	8,000	No	10	4.56	75W
• 45075	CFL23/27/T2	CFL T2 Spirals	23W	Medium (E26)	120V	2700K	82	1380	8,000	No	10	4.92	100W
• 45076	CFL23/35/T2	CFL T2 Spirals	23W	Medium (E26)	120V	3500K	82	1600	10000	No	10	4.92	100W
• 45079	CFL23/50/T2	CFL T2 Spirals	23W	Medium (E26)	120V	5000K	82	1380	8,000	No	10	4.92	100W
• 45080	CFL26/27/T2	CFL T2 Spirals	26W	Medium (E26)	120V	2700K	82	1750	10,000	No	10	5.08	100W
• 45082	CFL26/41/T2	CFL T2 Spirals	26W	Medium (E26)	120V	4100K	82	1750	10,000	No	10	5.08	100W
• 45083	CFL26/50/T2	CFL T2 Spirals	26W	Medium (E26)	120V	5000K	82	1750	10,000	No	10	5.08	100W
45030	CFL9/27	CFL T2 Spirals	9W	Medium (E26)	120V	2700K	82	500	10,000	No	10	4.06	40W

■ Indicates product is IP20 rated



[SPEC SHEET AVAILABLE HERE.](#)

Compact Fluorescent Lamps 2 Pin/4 Pin

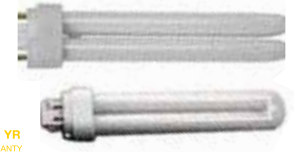

Product #	Product Code	Description	Wattage	Base	Voltage	Color Temp.	CRI	Lumens	Useful Life	Dimmable	Pkg. Qty	MOL	Eq. Wattage
CFL Double Tube 2-Pin													
109146	PL13D/27/ECO	CFL Double Tube 2-Pin	13W	GX23-2	120V	2700K	82	900	12,000	Yes	1	4.65	
109148	PL13D/35/ECO	CFL Double Tube 2-Pin	13W	GX23-2	120V	3500K	82	900	12,000	Yes	1	4.65	
109150	PL13D/41/ECO	CFL Double Tube 2-Pin	13W	GX23-2	120V	4100K	82	900	12,000	Yes	1	4.65	
109149	PL13D/50/ECO	CFL Double Tube 2-Pin	13W	GX23-2	120V	5000K	82	900	12,000	Yes	1	4.65	
109152	PL18D/27/ECO	CFL Double Tube 2-Pin	18W	G24D-2	120V	2700K	82	1200	12,000	Yes	1	5.9	
109154	PL18D/35/ECO	CFL Double Tube 2-Pin	18W	G24D-2	120V	3500K	82	1200	12,000	Yes	1	5.9	
109156	PL18D/41/ECO	CFL Double Tube 2-Pin	18W	G24D-2	120V	4100K	82	1200	12,000	Yes	1	5.9	
• 109862	PL22D/28	CFL Double Tube 2-Pin	22W	GX32D-2	120V	2800K	82	1200	10,000	No	10	6.15	
• 109864	PL22D/50	CFL Double Tube 2-Pin	22W	GX32D-2	120V	5000K	82	1200	10,000	No	10	6.15	
109158	PL26D/27/ECO	CFL Double Tube 2-Pin	26W	G24D-3	120V	2700K	82	1800	12,000	Yes	1	6.7	
109160	PL26D/35/ECO	CFL Double Tube 2-Pin	26W	G24D-3	120V	3500K	82	1800	12,000	Yes	1	6.7	
109162	PL26D/41/ECO	CFL Double Tube 2-Pin	26W	G24D-3	120V	4100K	82	1800	12,000	Yes	1	6.7	
109163	PL26D/50/ECO	CFL Double Tube 2-Pin	26W	G24D-3	120V	5000K	82	1800	12,000	Yes	1	6.7	
109870	PL28D/28	CFL Double Tube 2-Pin	28W	GX32D-3	120V	2800K	82	1800	10,000	No	10	6.6	
109868	PL28D/50	CFL Double Tube 2-Pin	28W	GX32D-3	120V	5000K	82	1800	10,000	No	10	6.6	
CFL Double Tube 4-Pin Elec.													
109037	PL13D/E/27/ECO	CFL Double Tube 4-Pin Elec.	13W	G24Q-1	120V	2700K	82	900	12,000	Yes	1	5.16	
109035	PL13D/E/30/ECO	CFL Double Tube 4-Pin Elec.	13W	G24Q-1	120V	3000K	82	900	12,000	Yes	1	5.16	
109038	PL13D/E/35/ECO	CFL Double Tube 4-Pin Elec.	13W	G24Q-1	120V	3500K	82	900	12,000	Yes	1	5.16	
109039	PL13D/E/41/ECO	CFL Double Tube 4-Pin Elec.	13W	G24Q-1	120V	4100K	82	900	12,000	Yes	1	5.16	
109122	PL13D/E/50/ECO	CFL Double Tube 4-Pin Elec.	13W	G24Q-1	120V	5000K	82	900	12,000	Yes	1	5.16	
109010	PL18D/E/27/ECO	CFL Double Tube 4-Pin Elec.	18W	G24D-2	120V	2700K	82	1200	12,000	Yes	1	5.6	
109012	PL18D/E/35/ECO	CFL Double Tube 4-Pin Elec.	18W	G24D-2	120V	3500K	82	1200	12,000	Yes	1	5.6	
109013	PL18D/E/41/ECO	CFL Double Tube 4-Pin Elec.	18W	G24D-2	120V	4100K	82	1200	12,000	Yes	1	5.6	
109074	PL18D/E/50/ECO	CFL Double Tube 4-Pin Elec.	18W	G24D-2	120V	5000K	82	1200	12,000	Yes	1	5.6	
109090	PL26D/E/27/ECO	CFL Double Tube 4-Pin Elec.	26W	G24Q-3	120V	2700K	82	1800	12,000	Yes	1	6.4	
109092	PL26D/E/35/ECO	CFL Double Tube 4-Pin Elec.	26W	G24Q-3	120V	3500K	82	1800	12,000	Yes	1	6.4	
109094	PL26D/E/41/ECO	CFL Double Tube 4-Pin Elec.	26W	G24Q-3	120V	4100K	82	1800	12,000	Yes	1	6.4	
109096	PL26D/E/50/ECO	CFL Double Tube 4-Pin Elec.	26W	G24Q-3	120V	5000K	82	1800	12,000	Yes	1	6.4	

■ Indicates product is IP20 rated



SPEC SHEET AVAILABLE HERE.



Compact Fluorescent Lamps High Lumen 4-Pin

Product #	Product Code	Description	Wattage	Base	Voltage	Color Temp.	CRI	Lumens	Useful Life	Dimmable	Pkg. Qty	MOL	Eq. Wattage
CFL High Lumen 4-Pin													
109238	FML27/NDL	CFL High Lumen 4-Pin	27W	GX10Q-4	120V	5000K	82	1700	8,000	No	10	5.9	
CFL High Lumen Long 4-Pin													
109700	PLL18/835/ECO	CFL High Lumen Long 4-Pin	18W	2G11	120V	3500K	82	1250	16,000	Yes	10	8.94	
109704	PLL24/835/ECO	CFL High Lumen Long 4-Pin	24W	2G11	120V	3500K	82	1800	16,000	Yes	10	12.7	
109706	PLL24/841/ECO	CFL High Lumen Long 4-Pin	24W	2G11	120V	4100K	82	1800	16,000	Yes	10	12.7	
109708	PLL36/835/ECO	CFL High Lumen Long 4-Pin	36W	2G11	120V	3500K	82	2800	16,000	Yes	10	16.4	
109710	PLL36/841/ECO	CFL High Lumen Long 4-Pin	36W	2G11	120V	4100K	82	2800	16,000	Yes	10	16.4	
109712	PLL40/830/RS/ECO	CFL High Lumen Long 4-Pin	40W	2G11	120V	3000K	82	3150	20,000	Yes	10	22.5	
109714	PLL40/835/RS/ECO	CFL High Lumen Long 4-Pin	40W	2G11	120V	3500K	82	3150	20,000	Yes	10	22.5	
109716	PLL40/841/RS/ECO	CFL High Lumen Long 4-Pin	40W	2G11	120V	4100K	82	3150	20,000	Yes	10	22.5	
44900	PLL40/850/RS/ECO	CFL High Lumen Long 4-Pin	40W	2G11	120V	5000K	82	3150	20,000	Yes	10	22.5	
109718	PLL55/835/ECO	CFL High Lumen Long 4-Pin	55W	2G11	120V	3500K	82	4700	20,000	Yes	10	21.2	

SPEC SHEET AVAILABLE HERE.



Compact Fluorescent Lamps Tube 2 Pin/4 Pin

Product #	Product Code	Description	Wattage	Base	Voltage	Color Temp.	CRI	Lumens	Useful Life	Dimmable	Pkg. Qty	MOL	Eq. Wattage
CFL Single Tube 2 Pin													
109126	PL13S/27/ECO	CFL Single Tube 2 Pin	13W	GX23	120V	2700K	82	800	12,000	Yes	1	7	
109128	PL13S/35/ECO	CFL Single Tube 2 Pin	13W	GX23	120V	3500K	82	800	12,000	Yes	1	7	
109130	PL13S/41/ECO	CFL Single Tube 2 Pin	13W	GX23	120V	4100K	82	800	12,000	Yes	1	7	
109132	PL13S/50/ECO	CFL Single Tube 2 Pin	13W	GX23	120V	5000K	82	800	12,000	Yes	1	7	
109100	PL5S/27/ECO	CFL Single Tube 2-Pin	5W	G23	120V	2700K	82	250	12,000	Yes	1	4.1	
109102	PL5S/41/ECO	CFL Single Tube 2-Pin	5W	G23	120V	4100K	82	250	12,000	Yes	1	4.1	
109106	PL7S/27/ECO	CFL Single Tube 2-Pin	7W	G23	120V	2700K	82	400	12,000	Yes	1	5.2	
109107	PL7S/35/ECO	CFL Single Tube 2-Pin	7W	G23	120V	3500K	82	400	12000	Yes	1	5.2	
109108	PL7S/41/ECO	CFL Single Tube 2-Pin	7W	G23	120V	4100K	82	400	12,000	Yes	1	5.2	
109112	PL9S/27/ECO	CFL Single Tube 2-Pin	9W	G23	120V	2700K	82	600	12,000	Yes	1	6.4	
109116	PL9S/41/ECO	CFL Single Tube 2-Pin	9W	G23	120V	4100K	82	600	12000	Yes	1	6.4	
109118	PL9S/50/ECO	CFL Single Tube 2-Pin	9W	G23	120V	5000K	82	600	12,000	Yes	1	6.4	
CFL Single Tube 4-Pin Elec.													
109134	PL13S/E/27/ECO	CFL Single Tube 4-Pin Elec.	13W	2GX7	120V	2700K	82	800	12,000	Yes	1	6.5	
109136	PL13S/E/35/ECO	CFL Single Tube 4-Pin Elec.	13W	2GX7	120V	3500K	82	800	12,000	Yes	1	6.5	
109138	PL13S/E/41/ECO	CFL Single Tube 4-Pin Elec.	13W	2GX7	120V	4100K	82	800	12,000	Yes	1	6.5	

Continue to next page for additional product information



109140	PL13S/E/50/ECO	CFL Single Tube 4-Pin Elec.	13W	2GX7	120V	5000K	82	800	12,000	Yes	1	6.5
44801	PL18T/E/35/ECO	CFL Triple Tube 4-Pin Elec.	18W	GX24Q-2	120V	3500K	82	1200	12,000	Yes	1	4.4
44803	PL18T/E/41/ECO	CFL Triple Tube 4-Pin Elec.	18W	GX24Q-2	120V	4100K	82	1200	12,000	Yes	1	4.4
109020	PL26T/E/27/ECO	CFL Triple Tube 4-Pin Elec.	26W	GX24Q-3	120V	2700K	82	1800	12,000	Yes	1	5
109022	PL26T/E/35/ECO	CFL Triple Tube 4-Pin Elec.	26W	GX24Q-3	120V	3500K	82	1800	12,000	Yes	1	5
109024	PL26T/E/41/ECO	CFL Triple Tube 4-Pin Elec.	26W	GX24Q-3	120V	4100K	82	1800	12,000	Yes	1	5
109076	PL26T/E/50/ECO	CFL Triple Tube 4-Pin Elec.	26W	GX24Q-3	120V	5000K	82	1800	12,000	Yes	1	5
109026	PL32T/E/27/ECO	CFL Triple Tube 4-Pin Elec.	32W	GX24Q-3	120V	2700K	82	2400	12,000	Yes	1	5.5
109028	PL32T/E/35/ECO	CFL Triple Tube 4-Pin Elec.	32W	GX24Q-3	120V	3500K	82	2400	12,000	Yes	1	5.5
109030	PL32T/E/41/ECO	CFL Triple Tube 4-Pin Elec.	32W	GX24Q-3	120V	4100K	82	2400	12,000	Yes	1	5.5
109070	PL32T/E/50/ECO	CFL Triple Tube 4-Pin Elec.	32W	GX24Q-3	120V	5000K	82	2400	12,000	Yes	1	5.5
109032	PL42T/E/27/ECO	CFL Triple Tube 4-Pin Elec.	42W	GX24Q-4	120V	2700K	82	3200	12,000	Yes	1	6.5
109034	PL42T/E/35/ECO	CFL Triple Tube 4-Pin Elec.	42W	GX24Q-4	120V	3500K	82	3200	12,000	Yes	1	6.5
109036	PL42T/E/41/ECO	CFL Triple Tube 4-Pin Elec.	42W	GX24Q-4	120V	4100K	82	3200	12,000	Yes	1	6.5
109072	PL42T/E/50/ECO	CFL Triple Tube 4-Pin Elec.	42W	GX24Q-4	120V	5000K	82	3200	12,000	Yes	1	6.5
44807	PL57T/E/41/ECO	CFL Triple Tube 4-Pin Elec.	57W	GX24Q-5	120V	4100K	82	4200	12,000	Yes	1	7.7

SPEC SHEET AVAILABLE HERE.

Covershield Linear T5/T8 Tubes



Product #	Product Code	Description	Wattage	Base	Voltage	Color Temp.	CRI	Lumens	Useful Life	Dimmable	Pkg. Qty	MOL	Eq. Wattage
Covershield Linear T5 Tube													
90051	F54T5/835/HO/ECO/IC/CS	Covershield Linear T5 Tube	54W	Miniature Bi-Pin		3500K	86	5000	24,000		25	48	
90052	F54T5/841/HO/ECO/IC/CS	Covershield Linear T5 Tube	54W	Miniature Bi-Pin		4100K	86	5000	24,000		25	48	
90053	F54T5/850/HO/ECO/IC/CS	Covershield Linear T5 Tube	54W	Miniature Bi-Pin		5000K	86	5000	24,000		25	48	
Covershield Linear T8 Tube													
90094	F32T8/835/ECO/CS	Covershield Linear T8 Tube	32W	Medium Bi-Pin		3500K	86	3050	24,000			48	
90095	F32T8/841/ECO/CS	Covershield Linear T8 Tube	32W	Medium Bi-Pin		4100K	86	3050	24,000			48	
90096	F32T8/850/ECO/CS	Covershield Linear T8 Tube	32W	Medium Bi-Pin		5000K	86	3050	24,000			48	

SPEC SHEET AVAILABLE HERE.

Covershield BR40 Lamps



Product #	Product Code	Description	Wattage	Base	Voltage	Color Temp.	CRI	Lumens	Useful Life	Dimmable	Pkg. Qty	MOL	Eq. Wattage
Covershield BR40 Clear Heat Bulb													
90320	BR40CL125/1/CSTF	Covershield BR40 Clear Heat Bulb	125W	Medium (E26)	120V		99		6,000	Yes	12	6.56	
404066	BR40CL250/1/CSTF	Covershield BR40 Clear Heat Bulb	250W	Medium (E26)	120V		99		5,000	Yes	12		



[SPEC SHEET AVAILABLE HERE.](#)

Covershield R40 Flood Lamps



Product #	Product Code	Description	Wattage	Base	Voltage	Color Temp.	CRI	Lumens	Useful Life	Dimmable	Pkg. Qty	MOL	Eq. Wattage
Covershield R40 Flood													
104050	R40CL375/CSTF	Covershield R40 Flood	375W	Medium (E26)	120V		99		5,000	Yes	12		
404071	R40RED250/10/CSTF	Covershield R40 Red Flood	250W	Medium (E26)	120V	Red	99		5,000	Yes	12		

[SPEC SHEET AVAILABLE HERE.](#)

Covershield MH Lamps



Product #	Product Code	Description	Wattage	Base	Voltage	Color Temp.	CRI	Lumens	Useful Life	Dimmable	Pkg. Qty	MOL	Eq. Wattage
Covershield MH Clear Base Up Bulb													
60502	MP400/BU/CSTF	Covershield MH Clear Base Up Bulb	400W	Mogul (E39)		4000K	65	36000	20,000	Yes	1		
108600	MH400/U/CSTF	Covershield MH ED37 Clear Bulb	400W	Mogul (E39)		4000K	65	36000	20,000	Yes	1		
Covershield MH ED28 Clear Bulb													
108604	MH250/U/CSTF	Covershield MH ED28 Clear Bulb	250W	Mogul (E39)		4000K	65	21800	10,000	Yes	1	8.25	

[SPEC SHEET AVAILABLE HERE.](#)

MH11 Halogen Flood Lamps



Product #	Product Code	Description	Wattage	Base	Voltage	Color Temp.	CRI	Lumens	Useful Life	Dimmable	Pkg. Qty	MOL	Eq. Wattage
GU10													
107544	MR11FL20/L/GU10	MR11 Halogen Flood	20W	GU10	120V	2900K	99	100	2,000	Yes	10	1.88	
107546	MR11FL35/L/GU10	MR11 Halogen Flood	35W	GU10	120V	2900K	99	250	2,000	Yes	10	1.88	
GU4													
107516	MR11FL5/L	MR11 Halogen Flood	5W	GU4	12V	2900K	99		3,000	Yes	10	1.38	
107102	MR11FTC/L	MR11 Halogen Medium Flood	20W	GU4	12V	2900K	99		3,000	Yes	10	1.38	
107104	MR11FTD/L	MR11 Halogen Narrow Spot	20W	GU4	12V	2900K	99		3,000	Yes	10	1.38	
BA15D													
107103	MR11FTC/L/TL	MR11 Halogen Flood Twist Lock	20W	BA15D	12V	2900K	99		3,000	Yes	10	1.77	
107105	MR11FTD/L/TL	MR11 Halogen Flood Twist Lock	20W	BA15D	12V	2900K	99		3,000	Yes	10	1.77	
107456	MR11FTF/L/TL	MR11 Halogen Flood Twist Lock	35W	BA15D	12V	2900K	99		3,000	Yes	10	1.77	



SPEC SHEET AVAILABLE HERE.

MH16 Halogen Flood Lamps



Product #	Product Code	Description	Wattage	Base	Voltage	Color Temp.	CRI	Lumens	Useful Life	Dimmable	Pkg. Qty	MOL	Eq. Wattage
GU5.3													
70710	MR16BAB/L/AL/24V	MR16 Halogen Flood	20W	GU5.3	24V	2950K	99		5,000	Yes	10	1.77	
107452	MR16EXN/24V	MR16 Halogen Flood	50W	GU5.3	24V	2900K	99		4,000	Yes	10	1.77	
107514	MR16EXN/L/HX	MR16 Halogen Flood	50W	GU5.3	12V	3000K	99		10,000	Yes	10	1.87	
107125	MR16EXN/L/SC	MR16 Halogen Flood	50W	GU5.3	12V	3050K	99		5,000	Yes	10	1.97	
107124	MR16EXN/SC	MR16 Halogen Flood	50W	GU5.3	12V	3050K	99		5,000	Yes	10	1.97	
70761	MR16EYC/L/AL	MR16 Halogen Flood	75W	GU5.3	12V	2900K	99		5,000	Yes	10	1.77	
70714	MR16FMW/L/AL/24V	MR16 Halogen Flood	35W	GU5.3	24V	2900K	99		3,000	Yes	10	1.77	
107356	MR16EXN/BLK/L	MR16 Halogen Flood Black Back	50W	GU5.3	12V	2900K	99		2,000	Yes	10	1.87	
107358	MR16EXN/SIL/L	MR16 Halogen Flood Silver Back	50W	GU5.3	12V	3000K	99		2,000	Yes	10	1.87	
107127	MR16EXT/L/SC	MR16 Halogen Spot	50W	GU5.3	12V	3050K	99		5,000	Yes	10	1.97	
G8													
108510	MR16EXN/G8	MR16 Halogen Flood	50W	G8	120V	2900K	99		2,000	Yes	10	1.77	
GU10													
107152	MR16FL20/L/GU10	MR16 Halogen Flood	20W	GU10	120V	2800K	99	110	2,000	Yes	10	2.16	
107154	MR16FL35/L/GU10	MR16 Halogen Flood	35W	GU10	120V	2800K	99	300	2,000	Yes	10	2.16	
107180	MR16FL50/L/GU10	MR16 Halogen Flood	50W	GU10	120V	2800K	99	465	2,000	Yes	10	2.16	
GU4													
108610	MR8W20/L	MR16 Halogen Wide Flood	20W	GU4	12V	3000K	99		3,000	Yes	10	1.3	

SPEC SHEET AVAILABLE HERE.

Covershield JC Halogen Lamps



Product #	Product Code	Description	Wattage	Base	Voltage	Color Temp.	CRI	Lumens	Useful Life	Dimmable	Pkg. Qty	MOL	Eq. Wattage
JC Type Halogen													
107008	JC10	JC Type Halogen	10W	G4	12V	2800K	99	120	3,000	Yes	10	1.18	
107710	JC10/HX	JC Type Halogen	10W	G4	12V	2750K	99	120	10,000	Yes	10	1.22	
107010	JC20	JC Type Halogen	20W	G4	12V	2800K	99	300	3,000	Yes	10	1.18	
107718	JC20/BA15S/HX	JC Type Halogen	20W	BA15S	12V	2850K	99	300	10,000	Yes	10	1.46	
107712	JC20/HX	JC Type Halogen	20W	G4	12V	2850K	99	300	10,000	Yes	10	1.22	
107012	JC35	JC Type Halogen	35W	G6.35	12V	2850K	99	600	3,000	Yes	10	1.58	
107014	JC50	JC Type Halogen	50W	G6.35	12V	2950K	99	900	3,000	Yes	10	1.58	
107009	JC20/6.35	JC Type Halogen	20W	G6.35	12V	2800K	99	300	3000	Yes	10	1.58	
107004	JC100	JC Type Halogen	100W	GY6.35	12V	3100K	99	2100	3,000	Yes	10	1.69	

Continue to next page for additional product information



107002	JC75	JC Type Halogen	75W	GY6.35	12V	3000K	99	1350	3,000	Yes	10	1.69
107070	JCD100/G8	JCD Type Halogen	100W	G8	130V	3050K	99	1400	2,000	Yes	10	1.69
107036	JCD20	JCD Type Halogen	20W	GY6.35	130V	2750K	99	180	2,000	Yes	10	1.69
107076	JCD20/G8	JCD Type Halogen	20W	G8	130V	2750K	99	180	2,000	Yes	10	1.69
71001	JCD25/G9	JCD Type Halogen	25W	G9	130V	2650K	99	280	2,000	Yes	10	1.65
107902	JCD25FR/G9	JCD Type Halogen	25W	G9	130V	2650K	99	280	2,000	Yes	10	1.65
107011	JCD35	JCD Type Halogen	35W	GY6.35	130V	2800K	99	350	2,000	Yes	10	1.69
107072	JCD35/G8	JCD Type Halogen	35W	G8	130V	2800K	99	350	2,000	Yes	10	1.69
107310	JCD40/FR/G9/120	JCD Type Halogen	40W	G9	130V	2800K	99	450	2,000	Yes	10	1.65
107906	JCD40/G9	JCD Type Halogen	40W	G9	120V	2750K	99	480	2,000	Yes	10	1.65
107908	JCD40FR/G9	JCD Type Halogen	40W	G9	130V	2750K	99	450	2,000	Yes	10	1.65
107015	JCD50	JCD Type Halogen	50W	GY6.35	130V	2900K	99	600	2,000	Yes	10	1.69
107074	JCD50/G8	JCD Type Halogen	50W	G8	130V	2900K	99	600	2,000	Yes	10	1.69
71002	JCD60/G9	JCD Type Halogen	60W	G9	130V	2950K	99	780	2,000	Yes	10	1.65
107904	JCD60FR/G9	JCD Type Halogen	60W	G9	130V	2950K	99	750	2,000	Yes	10	1.65
Double Ended J-Type Halogen												
107210	Q75T3C/S	Double Ended J-Type	75W	R7S	130V	2850K	99	1250	2,000	Yes	10	3.07
107198	Q1000T3C	Double Ended J-Type Halogen	1000W	R7S	240V	3050K	99	22000	2,000	Yes	10	10
107182	Q100T3C	Double Ended J-Type Halogen	100W	R7S	130V	2950K	99	1400	2,000	Yes	10	4.65
107184	Q100T3C/S	Double Ended J-Type Halogen	100W	R7S	130V	2950K	99	1400	2,000	Yes	10	3.07
107200	Q1500T3C	Double Ended J-Type Halogen	1500W	R7S	240V	3050K	99	33000	2,000	Yes	10	10
107202	Q1500T3C/277	Double Ended J-Type Halogen	1500W	R7S	277V	3050K	99	33000	2,000	Yes	10	10
107186	Q150T3C	Double Ended J-Type Halogen	150W	R7S	130V	2950K	99	2250	2,000	Yes	10	4.65
107214	Q150T3C/12V	Double Ended J-Type Halogen	150W	R7S	12V	2900K	99	2400	2,000	Yes	10	3.27
107188	Q150T3C/S	Double Ended J-Type Halogen	150W	R7S	130V	2950K	99	2400	2,000	Yes	10	3.07
107216	Q250T3C/83MM	Double Ended J-Type Halogen	250W	R7S	130V	2950K	99	4000	2,000	Yes	10	3.27
107208	Q250T3C/S	Double Ended J-Type Halogen	250W	R7S	130V	2950K	99	4000	2,000	Yes	10	3.07
107194	Q300T3C	Double Ended J-Type Halogen	300W	R7S	130V	2950K	99	5000	2,000	Yes	10	4.65
107196	Q500T3C	Double Ended J-Type Halogen	500W	R7S	130V	3000K	99	9500	2,000	Yes	10	4.65

Continue to next page for additional product information



Single Ended JD-Type Halogen

107025	Q100CL/DC	Single Ended JD-Type Halogen	100W	BA15D	130V	2950K	99	1700	2,000	Yes	10	2.4
127025	Q100CL/DC/120	Single Ended JD-Type Halogen	100W	BA15D	120V	2950K	99	1700	2,000	Yes	10	2.4
107029	Q150CL/DC	Single Ended JD-Type Halogen	150W	BA15D	130V	2950K	99	1615	2,000	Yes	10	2.4
71102	Q150CL/DC/120	Single Ended JD-Type Halogen	150W	BA15D	120V	2900K	99	2400	2,000	Yes	10	2.4
107033	Q250CL/DC	Single Ended JD-Type Halogen	250W	BA15D	130V	2900K	99	4500	2,000	Yes	10	3.12
107035	Q35CL/DC	Single Ended JD-Type Halogen	150W	BA15D	130V	2950K	99	2280	2,000	Yes	10	1.97
107018	Q50CL/DC	Single Ended JD-Type Halogen	35W	BA15D	130V	2700K	99	380	2,000	Yes	10	1.97
107021	Q75CL/DC	Single Ended JD-Type Halogen	50W	BA15D	130V	2800K	99	750	2,000	Yes	10	2.4

SPEC SHEET AVAILABLE HERE.

HID Lamps



Product #	Product Code	Description	Wattage	Base	Voltage	Color Temp.	CRI	Lumens	Useful Life	Dimmable	Pkg. Qty	MOL	Eq. Wattage
HID Ceramic MH													
67009	CDM150/U/830/MED	HID Ceramic MH Clear ED17 Bulb	150W	Medium (E26)		3000K	85	14000	16,000	Yes	12	5.45	
67001	CDM35/P30L/FL/830	HID Ceramic MH Clear PAR30L Flood	39W	Medium (E26)		3000K	85	2200	10,000	Yes	6	4.8	
67003	CDM70/P30L/FL/830	HID Ceramic MH Clear PAR30L Flood	70W	Medium (E26)		3000K	85	4850	10,000	Yes	12	4.8	
67026	CDM70/P30L/FL/942	HID Ceramic MH Clear PAR30L Flood	70W	Medium (E26)		4200K	90	4300	10,000	Yes	6	4.8	
67006	CDM35/TC/830	HID Ceramic MH Clear T4 Bulb	39W	G8.5		3000K	80	3300	12,000	Yes	12	3.15	
67007	CDM70/TC/830	HID Ceramic MH Clear T4 Bulb	70W	G8.5		3000K	85	6700	12,000	Yes	12	3.15	
67017	CDM70/TD/830	HID Ceramic MH Clear T6	70W	RX7S		3000K	85	6500	12,000	Yes	12	4.69	
67005	CDM150/T6/830	HID Ceramic MH Clear T6 Bulb	150W	G12		3000K	85	14000	12,000	Yes	12	3.94	
67002	CDM35/T6/830	HID Ceramic MH Clear T6 Bulb	39W	G12		3000K	80	3300	12,000	Yes	12	3.94	
67004	CDM70/T6/830	HID Ceramic MH Clear T6 Bulb	70W	G12		3000K	85	6700	12,000	Yes	12	3.94	
67014	CDM70/T6/942	HID Ceramic MH Clear T6 Bulb	70W	G12		4200K	90	6600	12,000	Yes	12	3.94	
67008	CDM70/U/830/MED	HID Ceramic MH Clear T7	70W	Medium (E26)		3000K	85	6200	16,000	Yes	12	5.45	
67020	CDM20/MR16N-FL/830/GX10	HID Ceramic MH MR16 Narrow Flood	20W	GX10		3000K	85	1100	12,000	Yes	60	2.56	



[SPEC SHEET AVAILABLE HERE.](#)

HID High Pressure Sodium Lamps



Product #	Product Code	Description	Wattage	Base	Voltage	Color Temp.	CRI	Lumens	Useful Life	Dimmable	Pkg. Qty	MOL	Eq. Wattage
HID High Pressure Sodium													
208126	LU150/ECO	HID HPS ED23.5 LU150 Bulb	150W	Mogul		2000K	20	15000	24,000	Yes	12	7.75	
108108	LU100/MED/ECO	HID HPS LU100 ED17 Bulb	100W	Medium (E26)		2000K	20	9600	24,000	Yes	12	5.43	
208124	LU100/ECO	HID HPS LU100 ED23.5 Bulb	100W	Mogul		2000K	20	9600	24,000	Yes	12	7.75	
279547	LU1000/ECO	HID HPS LU1000 ED25 Bulb	1000W	Mogul		2000K	20	130000	24,000	Yes	6	15.08	
108110	LU150/MED/ECO	HID HPS LU150 ED17 Bulb	150W	Medium (E26)		2000K	20	15000	24,000	Yes	12	5.71	
208130	LU250/ECO	HID HPS LU250 ED18 Bulb	250W	Mogul		2000K	20	28000	24,000	Yes	12	9.75	
467217	LU250/A	HID HPS LU250 ED58 Bulb		Mogul							12		
108102	LU35/MED/ECO	HID HPS LU35 ED17 Bulb	35W	Medium (E26)		2000K	20	2200	24,000	Yes	12	5.43	
208132	LU400/ECO	HID HPS LU400 ED18 Bulb	400W	Mogul		2000K	20	48000	24,000	Yes	12	9.75	
108104	LU50/MED/ECO	HID HPS LU50 ED17 Bulb	50W	Medium (E26)		2000K	20	3800	24,000	Yes	12	5.43	
208120	LU50/ECO	HID HPS LU50 ED23.5 Bulb	50W	Mogul		2000K	20	3800	24,000	Yes	12	7.75	
108106	LU70/MED/ECO	HID HPS LU70 ED17 Bulb	70W	Medium (E26)		2000K	20	6000	24,000	Yes	12	5.43	
208122	LU70/ECO	HID HPS LU70 ED23.5 Bulb	70W	Mogul		2000K	20	6000	24,000	Yes	12	7.75	

[SPEC SHEET AVAILABLE HERE.](#)

HID MH Coated



Product #	Product Code	Description	Wattage	Base	Voltage	Color Temp.	CRI	Lumens	Useful Life	Dimmable	Pkg. Qty	MOL	Eq. Wattage
HID Metal Halide Protected													
60507	MP100/C/U/MED/PS	HID MH Coated Base Up 100W	100W	Medium (E26)		3700K	65	8100	10,000	Yes	12	5.45	

[SPEC SHEET AVAILABLE HERE.](#)

HID MH Pulse Start Lamps



Product #	Product Code	Description	Wattage	Base	Voltage	Color Temp.	CRI	Lumens	Useful Life	Dimmable	Pkg. Qty	MOL	Eq. Wattage
HID Metal Halide Pulse Start													
108266	MP50/U/MED/PS	HID MH Pulse Start 50W	50W	Medium (E26)		4000K	65	3200	10,000	Yes	12	5.45	
108270	MP100/U/MED/PS	HID MH Pulse Start Clear 100W	100W	Medium (E26)		4000K	65	8500	10,000	Yes	12	5.45	
108272	MP150/U/MED/PS	HID MH Pulse Start Clear 150W	150W	Medium (E26)		4000K	65	14000	10,000	Yes	12	5.45	
108268	MP70/U/MED/PS	HID MH Pulse Start Clear 70W	70W	Medium (E26)		4000K	65	5300	10,000	Yes	12	5.45	
60511	MP200/BU/PS	HID MH Pulse Start Clear Base Up	250W	EX39		4000K	65	18000	15,000	Yes	12	8.25	



108298	MP250/BU/PS	HID MH Pulse Start Clear Base Up	250W	EX39	4000K	65	25000	15,000	Yes	12	8.25
108290	MP320/BU/PS	HID MH Pulse Start Clear Base Up	320W	EX39	4000K	65	30000	20,000	Yes	12	8.25
108296	MP400/BU/PS	HID MH Pulse Start Clear Base Up	400W	EX39	4000K	65	36000	20,000	Yes	6	11.5
60501	MP750/BU/PS	HID MH Pulse Start Clear Base Up	750W	EX39	4000K	65	75000	15,000	Yes	6	11.5
60503	MP150/C/U/MED/PS	HID MH Pulse Start Coated 150W	150W	Medium (E26)	3700K	65	13400	10,000	Yes	12	5.45
60508	MP70/C/U/MED/PS	HID MH Pulse Start Coated 70W	70W	Medium (E26)	3700K	65	5000	10,000	Yes	12	5.45
60510	MP250/C/BU/PS	HID MH Pulse Start Coated Base Up	250W	EX39	3700K	65	20000	15,000	Yes	12	8.25
108282	MP175/U/MED	HID Protected MH Clear 200W	200W	Medium (E26)	4000K	65	15000	10,000	Yes	12	5.45
60720	MP1000/BU	HID Protected MH Clear Base Up	1000W	EX39	4000K	65	105000	10,000	Yes	6	11.5
108286	MP175/BU	HID Protected MH Clear Base Up	175W	EX39	4000K	65	15000	10,000	Yes	12	8.25
108288	MP250/BU	HID Protected MH Clear Base Up	250W	EX39	4000K	65	21800	10,000	Yes	12	8.25
108292	MP360/BU/ES	HID Protected MH Clear Base Up	360W	EX39	4000K	65	34000	20,000	Yes	6	11.5
108294	MP400/BU	HID Protected MH Clear Base Up	400W	EX39	4000K	65	37000	15,000	Yes	6	11.5
60700	MP400/C/BU	HID Protected MH Coated Base Up	400W	EX39	3700K	65	39000	15,000	Yes	6	11.5
108291	MH350/BU/PS	HID MH Pulse Clear Base Up	350W	Mogul	4000K	65	37000	20,000	Yes	6	11.5
108280	MH400/BU/PS	HID MH Pulse Clear Base Up	400W	Mogul	4000K	65	42000	20,000	Yes	6	11.5
60009	MH250/HBU/PS	HID MH Pulse Clear Horiz Base Up	250W	Mogul	4000K	65	21000	15,000	Yes	12	8.25
60010	MH320/HBU/PS	HID MH Pulse Clear Horiz Base Up	320W	Mogul	4000K	65	31000	15,000	Yes	12	8.25
60016	MH750/HBU/PS	HID MH Pulse Clear Horiz Base Up	750W	Mogul	4000K	65	75000	10,000	Yes	6	11.5
60015	MH1000/U/PS	HID MH Pulse Start Clear	1000W	Mogul	4000K	65	110000	15,000	Yes	6	11.5
60014	MH875/U/PS	HID MH Pulse Start Clear	875W	Mogul	4000K	65	96000	15,000	Yes	6	11.5
108254	MH100/U/MED/PS	HID MH Pulse Start Clear 100W	100W	Medium (E26)	4000K	65	9100	15,000	Yes	12	5.45
60003	MH100/U/MOG/PS	HID MH Pulse Start Clear 100W	100W	Mogul	4000K	65	9100	15,000	Yes	12	8.25
108258	MH150/U/MED/PS	HID MH Pulse Start Clear 150W	150W	Medium (E26)	4000K	65	15000	15,000	Yes	12	5.45
108305	MH150/U/PS	HID MH Pulse Start Clear 150W	150W	Mogul	4000K	65	15000	15,000	Yes	12	8.25
60012	MH400/U/ED28/PS	HID MH Pulse Start Clear 400W	400W	Mogul	4000K	65	38000	20,000	Yes	12	8.25
60011	MH400/U/PS	HID MH Pulse Start Clear 400W	400W	Mogul	4000K	65	42000	20,000	Yes	6	11.5
108228	MH50/U/MED/PS	HID MH Pulse Start Clear 50W	50W	Medium (E26)	4000K	65	2100	10,000	Yes	12	5.45
108246	MH70/U/MED/PS	HID MH Pulse Start Clear 70W	70W	Medium (E26)	4000K	65	5800	10,000	Yes	12	5.45

Continue to next page for additional product information



60002	MH175/BU/MED/PS	HID MH Pulse Start Clear Base Up	175W	Medium (E26)	4000K	65	17500	15,000	Yes	12	5.45
108274	MH175/BU/PS	HID MH Pulse Start Clear Base Up	175W	Mogul	4000K	65	17500	15,000	Yes	12	8.25
108284	MH200/BU/PS	HID MH Pulse Start Clear Base Up	200W	Mogul	4000K	65	21000	12,000	Yes	12	8.25
108276	MH250/BU/PS	HID MH Pulse Start Clear Base Up	250W	Mogul	4000K	65	25000	15,000	Yes	12	8.25
108278	MH320/BU/PS	HID MH Pulse Start Clear Base Up	320W	Mogul	4000K	65	32000	20,000	Yes	12	8.25
60514	MP875/BU/PS	HID MH Pulse Start Clear Base Up	875W	EX39	4000K	65	93000	15,000	Yes	6	11.5
108256	MH100/C/U/MED/PS	HID MH Pulse Start Coated 100W	100W	Medium (E26)	3700K	70	8500	15,000	Yes	12	5.45
60008	MH175/HBU/PS	HID MH Pulse Start Coated 175W	175W	Mogul	4000K	65	15000	15,000	Yes	12	8.25
108248	MH70/C/U/MED/PS	HID MH Pulse Start Coated 70W	70W	Medium (E26)	3700K	65	5400	10,000	Yes	12	5.45



[SPEC SHEET AVAILABLE HERE.](#)

HID MH Double/Single/Standard

Product #	Product Code	Description	Wattage	Base	Voltage	Color Temp.	CRI	Lumens	Useful Life	Dimmable	Pkg. Qty	MOL	Eq. Wattage
HID Aquarium													
108416	MH400/U/T15/10K	HID Aquarium Clear 400W 10000K	400W	Mogul		10000K	80	25000	10,000	Yes	12	10.75	
HID Metal Halide Double End													
108402	MH70DE/UVS/3K	HID MH Double End Clear UV Stop	70W	R7S		3000K	65	5600	10,000	Yes	24	4.65	
108400	MH70DE/UVS/4K	HID MH Double End Clear UV Stop	70W	R7S		4000K	65	5600	10,000	Yes	24	4.65	
HID Metal Halide Single End													
108430	MH150SE/UVS/3K	HID MH Single Ended Clear UV Stop	150W	G12		3000K	65	14000	10,000	Yes	24	4.3	
108434	MH70SE/UVS/3K	HID MH Single Ended Clear UV Stop	70W	G12		3000K	65	5600	10,000	Yes	24	4.3	
108428	MH70SE/UVS/4K	HID MH Single Ended Clear UV Stop	70W	G12		4000K	65	5600	10,000	Yes	24	4.3	
HID Metal Halide Standard													
64431	MH1500HBU	HID Standard MH Horiz Base Up	1500W	Mogul		4000K	70	170000	3,000	Yes	6	15.4	
64469	MH1000/BT37	HID Standard MH 1000W	1000W	Mogul		3800K	65	110000	9,000	Yes	6	11.5	
64468	MH1000U/M	HID Standard MH 1000W	1000W	Mogul		4000K	65	108000	15,000	Yes	6	15.37	
64030/SYL	MH175U/M	HID Standard MH 175W	175W	Mogul		4200K	65	12800	7,500	Yes	12	8.31	
108220	MH250/HBU/T15	HID Standard MH Clear	250W	Mogul		4000K	65	20000	10,000	Yes	12	10.08	

Continue to next page for additional product information



108218	MH400/HBU/ED18	HID Standard MH Clear	400W	Mogul	4000K	65	38000	15,000	Yes	12	9.75
108222	MH1000/U	HID Standard MH Clear 1000W	1000W	Mogul	4000K	65	110000	12,000	Yes	6	15.4
108226	MH1000/U/BT37	HID Standard MH Clear 1000W	1000W	Mogul	4000K	65	110000	12,000	Yes	6	11.5
108200	MH175/U	HID Standard MH Clear 175W	175W	Mogul	4000K	65	15200	10,000	Yes	12	8.25
108262	MH175/U/MED	HID Standard MH Clear 175W	175W	Medium (E26)	4000K	65	15000	10,000	Yes	12	5.45
108204	MH250/U	HID Standard MH Clear 250W	250W	Mogul	4000K	65	21000	10,000	Yes	12	8.25
108208	MH400/U	HID Standard MH Clear 400W	400W	Mogul	4000K	65	40000	20,000	Yes	6	11.5
108216	MH400/U/ED28	HID Standard MH Clear 400W	400W	Mogul	4000K	65	39000	15,000	Yes	12	8.25
108214	MH1500/BU	HID Standard MH Clear Base Up	1500W	Mogul	4000K	65	175000	4,000	Yes	6	15.4
108212	MH360/BU/ES	HID Standard MH Clear Base Up	360W	Mogul	4000K	65	36000	20,000	Yes	6	11.5
108202	MH175/C/U	HID Standard MH Coated 175W	175W	Mogul	3700K	65	14800	10,000	Yes	12	8.25
108264	MH175/C/U/MED	HID Standard MH Coated 175W	175W	Medium (E26)	3700K	65	14800	10,000	Yes	12	5.45
108206	MH250/C/U	HID Standard MH Coated 250W	250W	Mogul	3700K	65	20000	10,000	Yes	12	8.25
108210	MH400/C/U	HID Standard MH Coated 400W	400W	Mogul	3700K	65	39000	20,000	Yes	6	11.5
60201	MH400/C/U/ED28	HID Standard MH Coated 400W	400W	Mogul	3700K	65	39000	20,000	Yes	12	8.25

[SPEC SHEET AVAILABLE HERE.](#)

Incandescent Lamps A15/A19



Product #	Product Code	Description	Wattage	Base	Voltage	Color Temp.	CRI	Lumens	Useful Life	Dimmable	Pkg. Qty	MOL	Eq. Wattage
A15 Incandescent Lamps													
6013	A15CL15	A15 Incandescent Bulb	15W	Medium (E26)	130V	2700K	99	95	3,000	Yes	20	3.5	
6014	A15FR15	A15 Incandescent Bulb	15W	Medium (E26)	130V	2700K	99	90	3,000	Yes	20	3.5	
6016	A15CL25	A15 Incandescent Bulb	25W	Medium (E26)	130V	2700K	99	130	3,000	Yes	20	3.5	
6015	A15FR25	A15 Incandescent Bulb	25W	Medium (E26)	130V	2700K	99	120	3,000	Yes	20	3.5	
6017	A15CL40	A15 Incandescent Bulb	40W	Medium (E26)	130V	2700K	99	300	3,000	Yes	20	3.5	
6018	A15FR40	A15 Incandescent Bulb	40W	Medium (E26)	130V	2700K	99	290	3,000	Yes	20	3.5	
A19 Incandescent Lamps													
76017	A19FR40/VS	A19 Incandescent Rough Service	40W	Medium (E26)	130V	2700K	99	310	2,500	Yes	12	4.25	
101182	A19CL100/SB	A19 Incandescent Silver Bowl	100W	Medium (E26)	130V	2700K	99	830	5,000	Yes	12	4.25	
101180	A19CL60/SB	A19 Incandescent Silver Bowl	60W	Medium (E26)	130V	2700K	99		2,500	Yes	12	4.25	
101184	A19FR60/SB	A19 Incandescent Silver Bowl	60W	Medium (E26)	130V	2700K	99		5,000	Yes	12	4.25	
101190	A21FR100/SB	A19 Incandescent Silver Bowl	100W	Medium (E26)	130V	2700K	99	800	5,000	Yes	12	4.96	
8011	A19BG60	A19 Incandescent Bug Light	60W	Medium (E26)	130V	Yellow	99		2,000	Yes	20	4.25	



[SPEC SHEET AVAILABLE HERE.](#)

Incandescent Lamps R40



Product #	Product Code	Description	Wattage	Base	Voltage	Color Temp.	CRI	Lumens	Useful Life	Dimmable	Pkg. Qty	MOL	Eq. Wattage
R40 Incandescent Lamps													
104048	R40CL375	R40 Incandescent Heat Lamp	375W	Medium (E26)	120V	2700K	99	3700	5,000	Yes	12	6.61	
104044	R40RED250/10	R40 Incandescent Red Heat Lamp	250W	Medium (E26)	120V	Red	99		5,000	Yes	12	6.61	

[SPEC SHEET AVAILABLE HERE.](#)

Incandescent Lamps BR30



Product #	Product Code	Description	Wattage	Base	Voltage	Color Temp.	CRI	Lumens	Useful Life	Dimmable	Pkg. Qty	MOL	Eq. Wattage
BR30 Incandescent Lamps													
404028	BR30AMB65/5	BR30 Bulged Reflector Incand.	65W	Medium (E26)	130V	Amber	99		5,000	Yes	12	5.35	
404030	BR30BLU65/5	BR30 Bulged Reflector Incand.	65W	Medium (E26)	130V	Blue	99		5,000	Yes	12	5.35	
404031	BR30DPNK65/5	BR30 Bulged Reflector Incand.	65W	Medium (E26)	130V	Pink	99		5,000	Yes	12	5.35	
404046	BR30PNK65/5	BR30 Bulged Reflector Incand.	65W	Medium (E26)	130V	Pink	99		5,000	Yes	12	5.35	
404049	BR30RED65/5	BR30 Bulged Reflector Incand.	65W	Medium (E26)	130V	Red	99		5,000	Yes	12	5.35	
404053	BR30YEL65/5	BR30 Bulged Reflector Incand.	65W	Medium (E26)	130V	Yellow	99		5,000	Yes	12	5.35	

[SPEC SHEET AVAILABLE HERE.](#)

Incandescent Lamps BR38



Product #	Product Code	Description	Wattage	Base	Voltage	Color Temp.	CRI	Lumens	Useful Life	Dimmable	Pkg. Qty	MOL	Eq. Wattage
BR38 Incandescent Lamp													
404114	BR38GRN100	BR38 Bulged Reflector Incand.	100W	Medium (E26)	130V	Green	99		5,000	Yes	12	5.83	



[SPEC SHEET AVAILABLE HERE.](#)

Incandescent Lamps PS30 Elongated



Product #	Product Code	Description	Wattage	Base	Voltage	Color Temp.	CRI	Lumens	Useful Life	Dimmable	Pkg. Qty	MOL	Eq. Wattage
PS30 Elongated Incandescent Lamp													
401308	PS30CL300/P5	PS30 Elongated Incand. Bulb	300W	Medium (E26)	130V	2700K	99	3600	5,000	Yes	12	8.06	

[SPEC SHEET AVAILABLE HERE.](#)

Incandescent Lamps G25 Globe



Product #	Product Code	Description	Wattage	Base	Voltage	Color Temp.	CRI	Lumens	Useful Life	Dimmable	Pkg. Qty	MOL	Eq. Wattage
G25 Incandescent Globe Bulb													
102382	G25CL60/SB	G25 Incandescent Globe Bulb	60W	Medium (E26)	130V	2700K	99		3,500	Yes	10	4.5	

[SPEC SHEET AVAILABLE HERE.](#)

Incandescent Lamps R14/R20 Flood



Product #	Product Code	Description	Wattage	Base	Voltage	Color Temp.	CRI	Lumens	Useful Life	Dimmable	Pkg. Qty	MOL	Eq. Wattage
R14 Reflector Flood Incand. Bulb													
9101	R14INT40	R14 Reflector Flood Incand. Bulb	40W	Intermediate	130V	2520K	99	280	1,500	Yes	25	2.64	
R20 Reflector Flood Incand.													
104200	R20AMB50	R20 Reflector Flood Incand.	50W	Medium (E26)	130V	Amber	99		2,500	Yes	10	3.93	
9146	R20BLU50	R20 Reflector Flood Incand.	50W	Medium (E26)	130V	Blue	99		2,500	Yes	10	3.93	
9150	R20DPNK50	R20 Reflector Flood Incand.	50W	Medium (E26)	130V	Dawn Pink	99		2,500	Yes	10	3.93	
9108	R20PNK50	R20 Reflector Flood Incand.	50W	Medium (E26)	130V	Pink	99		2,500	Yes	10	3.93	
9142	R20RED50	R20 Reflector Flood Incand.	50W	Medium (E26)	130V	Red	99		2,500	Yes	10	3.93	



[SPEC SHEET AVAILABLE HERE.](#)

Incandescent Lamps S11/14 Sign/Appliance



Product #	Product Code	Description	Wattage	Base	Voltage	Color Temp.	CRI	Lumens	Useful Life	Dimmable	Pkg. Qty	MOL	Eq. Wattage
Sign/Appliance Incandescent S11													
9045	S11CL10	S11 Incandescent Sign/Appliance	10W	Intermediate	120V	2700K	99	80	2,000	Yes	25	2.56	
9050	S11N40	S11 Incandescent Sign/Appliance	40W	Intermediate	130V	2700K	99	370	1,500	Yes	25	2.56	
7017	S11CL7.5	S11 Incandescent Sign/Appliance	7.5W	Medium (E26)	130V	2700K	99	45	1,500	Yes	25	2.25	
7026	S11ORG7.5C	S11 Incandescent Sign/Appliance	7.5W	Medium (E26)	130V	Orange	99		1,500	Yes	25	2.25	
7019	S11RED7.5C	S11 Incandescent Sign/Appliance	7.5W	Medium (E26)	130V	Red	99		1,500	Yes	25	2.25	
7020	S11WH7.5C	S11 Incandescent Sign/Appliance	7.5W	Medium (E26)	130V	White	99		1,500	Yes	25	2.25	
Sign/Appliance Incandescent S14													
7028	S11YEL7.5C	S14 Incandescent Sign Bulb	7.5W	Medium (E26)	130V	Yellow	99		1,500	Yes	25	2.25	
9056	S14AMB11T	S14 Incandescent Sign Bulb	11W	Medium (E26)	130V	Amber	99		3,000	Yes	25	3.5	
9076	S14BLU11C	S14 Incandescent Sign Bulb	11W	Medium (E26)	130V	Blue	99		3,000	Yes	25	3.5	
9055	S14BLU11T	S14 Incandescent Sign Bulb	11W	Medium (E26)	130V	Blue	99		3,000	Yes	25	3.5	
9051	S14CL11	S14 Incandescent Sign Bulb	11W	Medium (E26)	130V	2700K	99	80	5,000	Yes	25	3.5	
9057	S14FR11	S14 Incandescent Sign Bulb	11W	Medium (E26)	130V	2700K	99	75	3,000	Yes	25	3.5	
9070	S14GRN11C	S14 Incandescent Sign Bulb	11W	Medium (E26)	130V	Green	99		3,000	Yes	25	3.5	
9054	S14GRN11T	S14 Incandescent Sign Bulb	11W	Medium (E26)	130V	Green	99		3,000	Yes	25	3.5	
105334	S14RED11C	S14 Incandescent Sign Bulb	11W	Medium (E26)	130V	Red	99		3,000	Yes	25	3.5	
9052	S14RED11T	S14 Incandescent Sign Bulb	11W	Medium (E26)	130V	Red	99		3,000	Yes	25	3.5	
9058	S14WH11C	S14 Incandescent Sign Bulb	11W	Medium (E26)	130V	White	99		3,000	Yes	25	3.5	
105336	S14YEL11C	S14 Incandescent Sign Bulb	11W	Medium (E26)	130V	Yellow	99		3,000	Yes	25	3.5	
9053	S14YEL11T	S14 Incandescent Sign Bulb	11W	Medium (E26)	130V	Yellow	99		3,000	Yes	25	3.5	

[SPEC SHEET AVAILABLE HERE.](#)

Incandescent Lamps S6 Candelabra



Product #	Product Code	Description	Wattage	Base	Voltage	Color Temp.	CRI	Lumens	Useful Life	Dimmable	Pkg. Qty	MOL	Eq. Wattage
S6 Indicator Incandescent Bulb													
9042	S6CL6	S6 Indicator Incandescent Bulb	6W	Candelabra	130V	2700K	99	30	1,500	Yes	25	1.97	



[SPEC SHEET AVAILABLE HERE.](#)

Incandescent T10/T6/T6.5/T7/T8 Tubes



Product #	Product Code	Description	Wattage	Base	Voltage	Color Temp.	CRI	Lumens	Useful Life	Dimmable	Pkg. Qty	MOL	Eq. Wattage
T10 Incandescent Tube													
9014	T10CL40	T10 Incandescent Tube	40W	Medium (E26)	130V	2700K	99	280	2,500	Yes	25	5	
T6 Incandescent Tube													
9028	T6.5FR20INT	T6 Incandescent Tube	20W	Intermediate	130V	2700K	99	150	2,500	Yes	25	5.47	
9021	T6CL15/145V	T6 Incandescent Tube	15W	Candelabra	145V	2700K	99	90	2,000	Yes	25	3.06	
T6.5 Incandescent Tube													
9022	T6.5CL20DC	T6.5 Incandescent Tube	20W	BA15D	130V	2700K	99	150	2,500	Yes	25	5.37	
9019	T6.5CL20INT	T6.5 Incandescent Tube	20W	Intermediate	130V	2700K	99	150	2,500	Yes	25	5.47	
9018	T6.5CL25INT	T6.5 Incandescent Tube	25W	Intermediate	130V	2700K	99	180	2,500	Yes	25	5.47	
106111	T6.5CL40INT	T6.5 Incandescent Tube	40W	Intermediate	130V	2700K	99	280	2,500	Yes	25	5.47	
9023	T6.5FR20DC	T6.5 Incandescent Tube	20W	BA15D	130V	2700K	99	150	2,500	Yes	25	5.37	
T7 Incandescent Tube													
9030	T6CL15/CAN	T7 Incandescent Tube	15W	Candelabra	130V	2700K	99	100	2,000	Yes	25	3.06	
9039	T7CL15CAN	T7 Incandescent Tube	15W	Candelabra	120V	2700K	99	100	2,000	Yes	25	2.25	
9038	T7CL15DC	T7 Incandescent Tube	15W	BA15D	120V	2700K	99	100	2,000	Yes	25	2.36	
T8 Incandescent Tube													
9032	T8CL25INT	T8 Incandescent Tube	25W	Intermediate	130V	2700K	99	180	2,500	Yes	25	2.62	

[SPEC SHEET AVAILABLE HERE.](#)

Fluorescent Tube F18 T8 Appliance/F32T8 Blacklight



Product #	Product Code	Description	Wattage	Base	Voltage	Color Temp.	CRI	Lumens	Useful Life	Dimmable	Pkg. Qty	MOL	Eq. Wattage
Fluorescent F18 T8 Appliance Tube													
109234	F18T8CW/K24	Fluorescent F18 T8 Appliance Tube	18W	Medium Bi-Pin		4100K	62	1175	7,500	No	25	24	
Fluorescent F32 T8 Blacklight Tube													
37200	F32T8BLB	Fluorescent F32 T8 Blacklight Tube	32W	Medium Bi-Pin		Blacklight			10,000	No	12	48	



SPEC SHEET AVAILABLE HERE.

Fluorescent Tube Circleline



Product #	Product Code	Description	Wattage	Base	Voltage	Color Temp.	CRI	Lumens	Useful Life	Dimmable	Pkg. Qty	MOL	Eq. Wattage
Fluorescent Circleline													
37507	FC12T9CW	Fluorescent FC12 T9 Circleline	32W	G10Q		4100K	62	2100	12,000	No	12	12	
37510	FC16T9CW	Fluorescent FC16 T9 Circleline	40W	G10Q		4100K	62	2900	12,000	No	12	16	
109080	FC22T5/835	Fluorescent FC22 T5 Circleline	22W	2GX13		3500K	82	1900	12,000	Yes	20	9	
109082	FC22T5/841	Fluorescent FC22 T5 Circleline	22W	2GX13		4100K	82	1900	12,000	Yes	20	9	
109084	FC40T5/835	Fluorescent FC40 T5 Circleline	40W	2GX13		3500K	82	3350	12,000	Yes	20	12	
109086	FC40T5/841	Fluorescent FC40 T5 Circleline	40W	2GX13		4100K	82	3350	12,000	Yes	20	12	
37504	FC9T9/830	Fluorescent FC8 T9 Circleline	30W	G10Q		3000K	86	1800	12,000	No	12	9	
37501	FC8T9CW	Fluorescent FC9 T9 Circleline	22W	G10Q		4100K	62	1150	12,000	No	12	8	

SPEC SHEET AVAILABLE HERE.

Fluorescent Tube F T5/T12



Product #	Product Code	Description	Wattage	Base	Voltage	Color Temp.	CRI	Lumens	Useful Life	Dimmable	Pkg. Qty	MOL	Eq. Wattage
Fluorescent F13 T5 Tube													
9232	F13T5WW	Fluorescent F13 T5 Tube	13W	Miniature Bi-Pin		3000K	65	870	6,000	No	10	21	
9231	F13T5CW	Fluorescent F13 T5 Tube	13W	Miniature Bi-Pin		4100K	65	740	6,000	No	10	21	
109370	F14T8CW	Fluorescent F14 T5 Tube	14W	Medium Bi-Pin		4100K	65	650	8,000	No	30	15	
109208	F15T8WW	Fluorescent F15 T5 Tube	15W	Medium Bi-Pin		3000K	65	845	8,000	No	30	18	
9202	F15T8CW	Fluorescent F15 T5 Tube	15W	Medium Bi-Pin		4100K	65	770	8,000	No	30	18	
109212	F15T8DL	Fluorescent F15 T5 Tube	15W	Medium Bi-Pin		6500K	74	770	8,000	No	30	18	
9225	F30T8CW	Fluorescent F30 T5 Tube	30W	Medium Bi-Pin		4100K	65	2100	9,000	No	30	35"	
9213	F4T5CW	Fluorescent F4 T5 Tube	4W	Miniature Bi-Pin		4100K	65	130	6,000	No	10	6	
248302/SYL	F48CW/M	Fluorescent F48 T12 Tube	39W	Single Pin		4100K	62	2950	9,000	Yes	15	48	
9200	F6T5CW	Fluorescent F6 T5 Tube	6W	Miniature Bi-Pin		4100K	65	240	6,000	No	10	9	
	F72CW/M	Fluorescent F72 T12 Tube	56W	Single Pin		4100K	59	4450	12,000	Yes	15	72	
9210	F8T5WW	Fluorescent F8 T5 Tube	8W	Miniature Bi-Pin		3000K	53	400	6,000	No	10	12	
9201	F8T5CW	Fluorescent F8 T5 Tube	8W	Miniature Bi-Pin		4100K	65	350	6,000	No	10	12	
9215	F8T5DL	Fluorescent F8 T5 Tube	8W	Miniature Bi-Pin		6500K	75	350	6,000	No	10	12	
372821	F96DX/M	Fluorescent F96 T12 Tube	75W	Single Pin		6500K	84	4775	12,000	Yes	15	96	

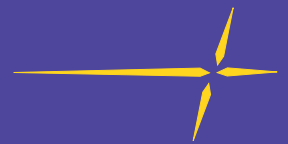

[SPEC SHEET AVAILABLE HERE.](#)

Fluorescent Tube FX T5

Product #	Product Code	Description	Wattage	Base	Voltage	Color Temp.	CRI	Lumens	Useful Life	Dimmable	Pkg. Qty	MOL	Eq. Wattage
Fluorescent F8 T5 Blacklight Tube													
9206	F8T5BLB	Fluorescent F8 T5 Blacklight Tube	8W	Miniature Bi-Pin		Blacklight			6,000	No	10	12	
Fluorescent F14 T5 Tube													
30117	F14T5/830/ECO/IC	Fluorescent F14 T5 Tube	14W	Miniature Bi-Pin		3000K	86	1350	24,000	Yes	25	22	
30118	F14T5/835/ECO/IC	Fluorescent F14 T5 Tube	14W	Miniature Bi-Pin		3500K	86	1350	24,000	Yes	25	22	
30119	F14T5/841/ECO/IC	Fluorescent F14 T5 Tube	14W	Miniature Bi-Pin		4100K	86	1350	24,000	Yes	25	22	
Fluorescent F21 T5 Tube													
30125	F21T5/830/ECO/IC	Fluorescent F21 T5 Tube	21W	Miniature Bi-Pin		3000K	86	2100	24,000	Yes	25	34	
30126	F21T5/835/ECO/IC	Fluorescent F21 T5 Tube	21W	Miniature Bi-Pin		3500K	86	2100	24,000	Yes	25	34	
30127	F21T5/841/ECO/IC	Fluorescent F21 T5 Tube	21W	Miniature Bi-Pin		4100K	86	2100	24,000	Yes	25	34	
Fluorescent F24 T5 Tube													
30134	F24T5/835/HO/ECO/IC	Fluorescent F24 T5 Tube HO	24W	Miniature Bi-Pin		3500K	86	2000	24,000	Yes	25	22	
30135	F24T5/841/HO/ECO/IC	Fluorescent F24 T5 Tube HO	24W	Miniature Bi-Pin		4100K	86	2000	24,000	Yes	25	22	
Fluorescent F28 T5 Tube													
35041	F28T5/830/ECO/IC	Fluorescent F28 T5 Tube	28W	Miniature Bi-Pin		3000K	86	2900	24,000	Yes	25	46	
35042	F28T5/835/ECO/IC	Fluorescent F28 T5 Tube	28W	Miniature Bi-Pin		3500K	86	2900	24,000	Yes	25	46	
35043	F28T5/841/ECO/IC	Fluorescent F28 T5 Tube	28W	Miniature Bi-Pin		4100K	86	2900	24,000	Yes	25	46	
35044	F28T5/850/ECO/IC	Fluorescent F28 T5 Tube	28W	Miniature Bi-Pin		5000K	86	2900	24,000	Yes	25	46	
Fluorescent F39 T5 Tube													
35061	F39T5/835/HO/ECO/IC	Fluorescent F39 T5 Tube HO	39W	Miniature Bi-Pin		3500K	86	3500	24,000	Yes	25	34	
35062	F39T5/841/HO/ECO/IC	Fluorescent F39 T5 Tube HO	39W	Miniature Bi-Pin		4100K	86	3500	24,000	Yes	25	34	
Fluorescent F49 T5 Tube													
35089	F49T5/850/HO/ECO	Fluorescent F49 T5 Tube HO	49W	Miniature Bi-Pin		5000K	86	4900	24,000	Yes	25	46	

Continue to next page for additional product information



Fluorescent F54 T5 Tube HO											
36081	F54T5/830/HO/ECO/G2	Fluorescent F54 T5 Tube HO	54W	Miniature Bi-Pin (G5)	3000K	85	4650	24,000	Yes	40	46
36082	F54T5/835/HO/ECO/G2	Fluorescent F54 T5 Tube HO	54W	Miniature Bi-Pin (G5)	3500K	85	4650	24,000	Yes	40	46
36083	F54T5/841/HO/ECO/G2	Fluorescent F54 T5 Tube HO	54W	Miniature Bi-Pin (G5)	4100K	85	4650	24,000	Yes	40	46
36084	F54T5/850/HO/ECO/G2	Fluorescent F54 T5 Tube HO	54W	Miniature Bi-Pin (G5)	5000K	85	4650	24,000	Yes	40	46
36086	F54T5/865/HO/ECO/G2	Fluorescent F54 T5 Tube HO	54W	Miniature Bi-Pin (G5)	6500K	85	4650	24,000	Yes	40	46
35082	F54T5/835/HO/ECO/IC	Fluorescent F54 T5 Tube HO	54W	Miniature Bi-Pin	3500K	86	5000	24,000	Yes	25	46
Fluorescent F40 T12 Tube											
35201	F40/950/ECO	Fluorescent F40 T12 Tube	40W	Medium Bi-Pin	5000K	90	2250	24,000	No	30	47.8
423889	F40CWS/ECO/M	Fluorescent F40 T12 Tube	40W	Medium Bi-Pin	4100K	89	2600	20,000	Yes	30	48
35200	F40CWX/ECO	Fluorescent F40 T12 Tube	40W	Medium Bi-Pin	4100K	90	2500	24,000	No	30	48
273599	F40DX/A	Fluorescent F40 T12 Tube	30W	Medium Bi-Pin	6500K	90	2325	20,000	Yes	30	48
35202	F40DX/ECO	Fluorescent F40 T12 Tube	40W	Medium Bi-Pin	6500K	90	2200	24,000	No	30	47.8
Fluorescent F96 T12 Tube											
423194	F96CWS/ECO/M	Fluorescent F96 T12 Tube	75W	Single Pin	4100K	89	5000	12,000	Yes	15	96
Fluorescent F17 T8 Tube											
109320	F17T8/730/ECO	Fluorescent F17 T8 Tube	17W	Medium Bi-Pin	3000K	78	1350	24,000	No	25	24
109322	F17T8/735/ECO	Fluorescent F17 T8 Tube	17W	Medium Bi-Pin	3500K	78	1350	24,000	No	25	24
109324	F17T8/741/ECO	Fluorescent F17 T8 Tube	17W	Medium Bi-Pin	4100K	78	1350	24,000	No	25	24
109326	F17T8/750/ECO	Fluorescent F17 T8 Tube	17W	Medium Bi-Pin	5000K	78	1350	24,000	No	25	24
35170	F17T8/830/ECO	Fluorescent F17 T8 Tube	17W	Medium Bi-Pin	3000K	86	1400	24,000	No	25	24
109802	F17T8/835/ECO	Fluorescent F17 T8 Tube	17W	Medium Bi-Pin	3500K	86	1400	24,000	No	25	24
109804	F17T8/841/ECO	Fluorescent F17 T8 Tube	17W	Medium Bi-Pin	4100K	86	1400	24,000	No	25	24
35180	F17T8/850/ECO	Fluorescent F17 T8 Tube	17W	Medium Bi-Pin	5000K	86	1400	24,000	No	25	24
Fluorescent F25 T8 Tube											
109342	F25T8/735/ECO	Fluorescent F25 T8 Tube	25W	Medium Bi-Pin	3500K	78	2150	24,000	No	25	36
109344	F25T8/741/ECO	Fluorescent F25 T8 Tube	25W	Medium Bi-Pin	4100K	78	2150	24,000	No	25	36
109346	F25T8/750/ECO	Fluorescent F25 T8 Tube	25W	Medium Bi-Pin	5000K	78	2150	24,000	No	25	36
109808	F25T8/835/ECO	Fluorescent F25 T8 Tube	25W	Medium Bi-Pin	3500K	86	2250	24,000	No	25	36
109810	F25T8/841/ECO	Fluorescent F25 T8 Tube	25W	Medium Bi-Pin	4100K	86	2250	24,000	No	25	36
35172	F25T8ES/835/ECO	Fluorescent F25 T8 Tube	25W	Medium Bi-Pin	3500K	86	2500	24,000	No	25	48
35173	F25T8ES/841/ECO	Fluorescent F25 T8 Tube	25W	Medium Bi-Pin	4100K	86	2500	24,000	No	25	48
35174	F25T8ES/850/ECO	Fluorescent F25 T8 Tube	25W	Medium Bi-Pin	5000K	86	2500	24,000	No	25	48

Continue to next page for additional product information



Fluorescent F28 T8 Tube											
35175	F28T8/830/ECO	Fluorescent F28 T8 Tube	28W	Medium Bi-Pin	3000K	86	2800	24,000	No	25	48
109364	F28T8/835/ECO	Fluorescent F28 T8 Tube	28W	Medium Bi-Pin	3500K	86	2800	24,000	No	25	48
109366	F28T8/841/ECO	Fluorescent F28 T8 Tube	28W	Medium Bi-Pin	4100K	86	2800	24,000	No	25	48
109368	F28T8/850/ECO	Fluorescent F28 T8 Tube	28W	Medium Bi-Pin	5000K	86	2800	24,000	No	25	48
Fluorescent F32 T8 Tube											
109398	F32T8/830/ECO	Fluorescent F32 T8 Tube	32W	Medium Bi-Pin	3000K	86	3050	24,000	No	25	48
109400	F32T8/835/ECO	Fluorescent F32 T8 Tube	32W	Medium Bi-Pin	3500K	86	3050	24,000	No	25	48
109402	F32T8/841/ECO	Fluorescent F32 T8 Tube	32W	Medium Bi-Pin	4100K	86	3050	24,000	No	25	48
109404	F32T8/850/ECO	Fluorescent F32 T8 Tube	32W	Medium Bi-Pin	5000K	86	3050	24,000	No	25	48
109428	F32T8/865/ECO	Fluorescent F32 T8 Tube	32W	Medium Bi-Pin	6500K	86	3050	24,000	No	25	48
35176	F32T8/835/ECO/HL	Fluorescent F32 T8 Tube High Lumen	32W	Medium Bi-Pin	3500K	86	3150	24,000	No	25	48
35177	F32T8/841/ECO/HL	Fluorescent F32 T8 Tube High Lumen	32W	Medium Bi-Pin	4100K	86	3150	24,000	No	25	48
35178	F32T8/850/ECO/HL	Fluorescent F32 T8 Tube High Lumen	32W	Medium Bi-Pin	5000K	86	3150	24,000	No	25	48
Fluorescent F58 T8 Tube											
35179	F58T8/840	Fluorescent F58 T8 Tube	58W	Medium Bi-Pin	4000K	86	5300	24,000	No	25	60
Fluorescent F70 T8 Tube											
62573	F70T8/840/M	Fluorescent F70 T8 Tube	70W	Medium Bi-Pin	4100K	85	6300	20,000	Yes	25	70
Fluorescent F96 T8 Tube											
22149	F96T8/841/M	Fluorescent F96 T8 Tube	59W	Single Pin	4100K	82	5900	18,000	Yes	24	96
22173	F96T8/850/M	Fluorescent F96 T8 Tube	59W	Single Pin	5000K	80	5900	15,000	Yes	24	96
Fluorescent F24 T12 Tube HO											
25313	F24T12CWHO/M	Fluorescent F24 T12 Tube HO	35W	Recessed Double Contact	4200K	60	1650	9,000	Yes	30	24
25314	F24T12DLHO/M	Fluorescent F24 T12 Tube HO	35W	Recessed Double Contact	6500K	76	1400	9,000	Yes	30	24
Fluorescent F30 T12 Tube HO											
25322	F30T12CWHO/M	Fluorescent F30 T12 Tube HO	45W	Recessed Double Contact	4200K	76	2500	9,000	Yes	30	28
Fluorescent F42 T12 Tube HO											
25342	F42CWHO/M	Fluorescent F42 T12 Tube HO	55W	Recessed Double Contact	4200K	60	3400	9,000	Yes	30	42
25343	F42DLHO/M	Fluorescent F42 T12 Tube HO	55W	Recessed Double Contact	6500K	76	3050	9,000	Yes	30	42
Fluorescent F48 T12 Tube HO											
369785	F48CWHO/M	Fluorescent F48 T12 Tube HO	60W	Recessed Double Contact	4100K	59	4050	12,000	Yes	15	48
369843	F48DLHO/M	Fluorescent F48 T12 Tube HO	60W	Recessed Double Contact	6500K	73	3400	12,000	Yes	15	48

Continue to next page for additional product information



Fluorescent F60 T12 Tube HO											
22513-25126	F60CWHO/M	Fluorescent F60 T12 Tube HO	75W	Recessed Double Contact	4200K	60	5200	12,000	Yes	30	60
22512-25120	F60DLHO/M	Fluorescent F60 T12 Tube HO	75W	Recessed Double Contact	6500K	76	4600	12,000	Yes	30	60
Fluorescent F72 T12 Tube HO											
366518	F72CWHO/M	Fluorescent F72 T12 Tube HO	85W	Recessed Double Contact	4100K	62	6350	12,000	Yes	15	72
366534	F72DLHO/M	Fluorescent F72 T12 Tube HO	85W	Recessed Double Contact	6500K	79	5600	12,000	Yes	15	72
Fluorescent F84 T12 Tube HO											
25384/SYL	F84CWHO/M	Fluorescent F84 T12 Tube HO	100W	Recessed Double Contact	4100K	62	7490	12,000	Yes	15	84
	F84DLHO/M	Fluorescent F84 T12 Tube HO	100W	Recessed Double Contact	6500K	76	6700	12,000	Yes	15	84
Fluorescent F96 T12 Tube HO											
381774	F96DLHO/A	Fluorescent F96 T12 Tube HO	110W	Recessed Double Contact	6500K	79	7800	12,000	Yes	15	96





 SPEC SHEET AVAILABLE HERE.



Fluorescent Tube U-Bend T12/T8

Product #	Product Code	Description	Wattage	Base	Voltage	Color Temp.	CRI	Lumens	Useful Life	Dimmable	Pkg. Qty	MOL	Eq. Wattage
Fluorescent U-Bend FB40 T12 Tube													
35203	FB40CWX/6/ECO	Fluorescent U-Bend FB40 T12 Tube	40W	Medium Bi-Pin		4100K	90	2200	18,000	Yes	12	22.5	
219931	FB40DX/6/M	Fluorescent U-Bend FB40 T12 Tube	40W	Medium Bi-Pin		6500K	90	2250	18,000	Yes	12	22.44	
Fluorescent U-Bend FB40 T12 Tube													
35320	FB28/835/6/ECO	Fluorescent U-Bend FB28 T8 Tube	28W	Medium Bi-Pin		3500K	86	2650	24,000	No	25	22.6	
35321	FB28/841/6/ECO	Fluorescent U-Bend FB28 T8 Tube	28W	Medium Bi-Pin		4100K	86	2650	24,000	No	25	22.6	
30301	FB31/830/ECO	Fluorescent U-Bend FB31 T8 Tube	31W	Medium Bi-Pin		3000K	86	2750	24,000	No	12	22.6	
30302	FB31/835/ECO	Fluorescent U-Bend FB31 T8 Tube	31W	Medium Bi-Pin		3500K	86	2750	24,000	No	12	22.6	
30303	FB31/841/ECO	Fluorescent U-Bend FB31 T8 Tube	31W	Medium Bi-Pin		4100K	86	2750	24,000	No	12	22.6	
30304	FB31/850/ECO	Fluorescent U-Bend FB31 T8 Tube	31W	Medium Bi-Pin		5000K	86	2750	24,000	No	12	22.6	
109812	FB32/830/6/ECO	Fluorescent U-Bend FB32 T8 Tube	32W	Medium Bi-Pin		3000K	86	2900	24,000	No	20	22.6	
109814	FB32/835/6/ECO	Fluorescent U-Bend FB32 T8 Tube	32W	Medium Bi-Pin		3500K	86	2900	24,000	No	20	22.6	
109816	FB32/841/6/ECO	Fluorescent U-Bend FB32 T8 Tube	32W	Medium Bi-Pin		4100K	86	2900	24,000	No	20	22.6	
109818	FB32/850/6/ECO	Fluorescent U-Bend FB32 T8 Tube	32W	Medium Bi-Pin		5000K	86	2900	24,000	No	20	22.6	



SPEC SHEET AVAILABLE HERE.

Incandescent Miniature Bayonet/Wedge



Product #	Product Code	Description	Wattage	Base	Voltage	Color Temp.	CRI	Lumens	Useful Life	Dimmable	Pkg. Qty	MOL	Eq. Wattage
Incandescent Miniature Bayonet													
1141	1141	Incandescent Miniature Bayonet		BA15S	12.8V		99		1,000	Yes	1000	2	
1156	1156	Incandescent Miniature Bayonet		BA15S	12.8V		99		1,200	Yes	1000	2	
1383	1383	Incandescent Miniature Bayonet		BA15S	28V		99		500	Yes	1000	2.63	
755	755	Incandescent Miniature Bayonet		BA9S	6.3V		99		20,000	Yes	1000	1.2	
93	93	Incandescent Miniature Bayonet		BA15S	12.8V		99		700	Yes	1000	2	
Incandescent Miniature Wedge													
912	912	Incandescent Miniature Wedge		Wedge	12.8V		99		1,000	Yes	1000	1.49	
918	918	Incandescent Miniature Wedge		Wedge	12.8V		99		500	Yes	1000	1.49	
921	921	Incandescent Miniature Wedge		Wedge	12.8V		99		500	Yes	1000	1.49	
65030	3155K	Incandescent Mini Plastic Wedge		Plastic Wedge	12.8V		99		2,000	Yes	1000	2.09	
65032	3156K	Incandescent Mini Plastic Wedge		Plastic Wedge	12.8V		99		2,000	Yes	1000	2.09	
3156	3156	Incandescent Mini Plastic Wedge		Plastic Wedge	12.8V		99		1,200	Yes	1000	2.09	

SPEC SHEET AVAILABLE HERE.

Incandescent Decorative Clear Flame Tip



Product #	Product Code	Description	Wattage	Base	Voltage	Color Temp.	CRI	Lumens	Useful Life	Dimmable	Pkg. Qty	MOL	Eq. Wattage
Incandescent Decorative Clear Flame Tip													
2502	CFTC3	Clear Flicker Flame Tip	3W	Candelabra	130V				2,000	Yes	25	2.87	
2003	CFC25	Decorative Clear Flame Tip	25W	Candelabra	130V			180	3,000	Yes	25	4.12	
2005	CFTC7.5	Decorative Clear Flame Tip	7.5W	Candelabra	130V			35	2,000	Yes	25	2.87	
2012	EFC25	Decorative Clear Flame Tip	25W	Medium (E26)	130V			180	3,000	Yes	25	4.12	
3001	F15CL25	Decorative Flame Clear	25W	Medium (E26)	130V			180	1,500	Yes	25	4.5	
2001	CFC15	Decorative Clear Flame Tip	15W	Candelabra	130V			100	2,000	Yes	25	4.12	
2020	CFCP15	Decorative Clear Flame Tip 25MM	15W	Candelabra	130V			100	2,000	Yes	25	3.58	
2021	CFCP25	Decorative Clear Flame Tip 25MM	25W	Candelabra	130V			220	1,500	Yes	25	3.58	



SPEC SHEET AVAILABLE HERE.

Incandescent Decorative Globe

Product #	Product Code	Description	Wattage	Base	Voltage	Color Temp.	CRI	Lumens	Useful Life	Dimmable	Pkg. Qty	MOL	Eq. Wattage
Incandescent Decorative Clear Globe													
4001	G16CL15	Decorative Clear Globe	15W	Candelabra	130V			100	2,000	Yes	25	3	
4002	G16CL25	Decorative Clear Globe	25W	Candelabra	130V			220	1,500	Yes	25	3	
5001	G25CL25	Decorative Clear Globe	25W	Medium (E26)	130V			150	3,500	Yes	10	4.5	
5003	G25CL40	Decorative Clear Globe	40W	Medium (E26)	130V			300	3,500	Yes	10	4.5	
Incandescent Decorative White Globe													
4015	G16WH15	Decorative White Globe	15W	Candelabra	130V			90	2,000	Yes	25	3	
4016	G16WH25	Decorative White Globe	25W	Candelabra	130V			180	1,500	Yes	25	3	
5002	G25WH25	Decorative White Globe	25W	Medium (E26)	130V			130	3,500	Yes	10	4.5	
5004	G25WH40	Decorative White Globe	40W	Medium (E26)	130V			280	3,500	Yes	10	4.5	

SPEC SHEET AVAILABLE HERE.

Incandescent Decorative Torpedo



Product #	Product Code	Description	Wattage	Base	Voltage	Color Temp.	CRI	Lumens	Useful Life	Dimmable	Pkg. Qty	MOL	Eq. Wattage
Incandescent Decorative Clear Torpedo													
1001	CTC15	Decorative Clear Torpedo	15W	Candelabra	130V			100	2,000	Yes	25	3.87	
1003	CTC25	Decorative Clear Torpedo	25W	Candelabra	130V			180	3,000	Yes	25	3.87	
121023	CTC25/E14	Decorative Clear Torpedo	25W	E14	120V			220	1,500	Yes	25	3.87	
1020	CTCP15	Decorative Clear Torpedo	15W	Candelabra	130V			100	2,000	Yes	25	3.42	
1021	CTCP25	Decorative Clear Torpedo	25W	Candelabra	130V			220	1,500	Yes	25	3.42	
1012	ETC25	Decorative Clear Torpedo	25W	Medium (E26)	130V			180	3,000	Yes	25	3.87	
3006	F15AMB40	Decorative Flame Amber	40W	Medium (E26)	130V				1,500	Yes	25	4.5	
Incandescent Decorative Frosted Torpedo													
100192	CTF25	Decorative Frosted Torpedo	25W	Candelabra	130V			170	3,000	Yes	25	3.87	
1013	ETF25	Decorative Frosted Torpedo	25W	Medium (E26)	130V			170	3,000	Yes	25	3.87	



LED LAMPS

Bulb & Base Shapes



PAR16

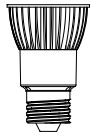

PAR16
(Colors Only)



PAR20
(RGB Only)

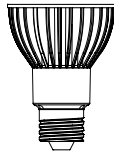

PAR20

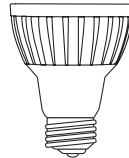

PAR20

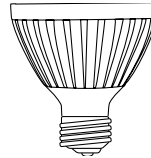

PAR30
Short Neck

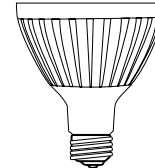

PAR30

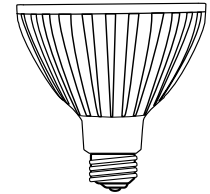

PAR38

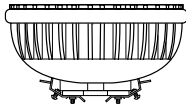

PAR36
IP67

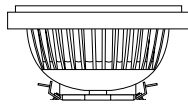

PAR36

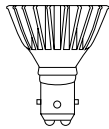

MR11
BA15d

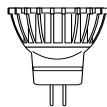

MR11

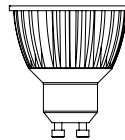

MR16
GU10

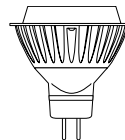

MR16



C7



C9

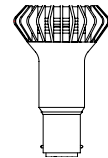

R12
BA15d

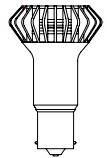

R12
BA15s

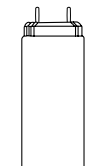

T8 Medium
Bi-Pin



A19

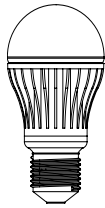

A19

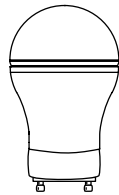

A19
GU24



CA10



B10



B11



B11

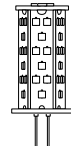

JC35

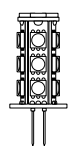

JC20

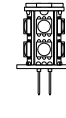

JC10

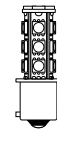

JC20
BA15s

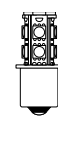

JC10
BA15s



JC G4
IP65

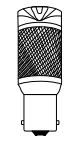

JC
BA15s



S14



S14 Clear

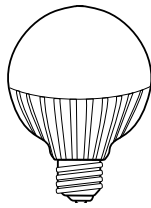

Globe

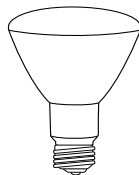

BR40/R40

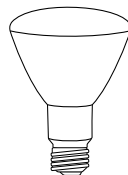

BR30

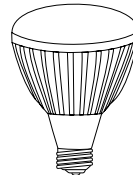

BR30

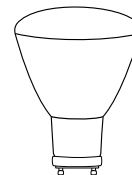

BR30
GU24



R20



Plastic
Wedge

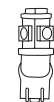

Mini
Wedge

Base Types

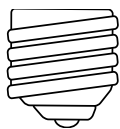

Medium
E26

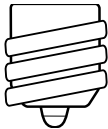

Candelabra
E12

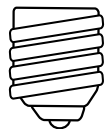

Intermediate
E17

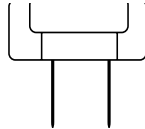

G4

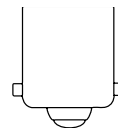

SC Bayonet
BA15s

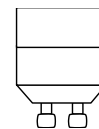

GU10

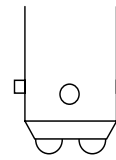

DC Bayonet
BA15d

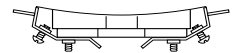

MP-Term

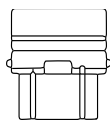

Plastic
Wedge

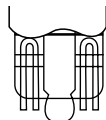

Wedge

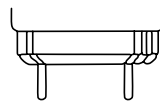

Medium
Bi-Pin
G13

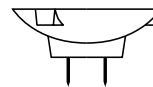

GU5.3

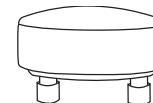

GU24



COMPACT FLUORESCENT LAMPS

Bulb & Base Shapes

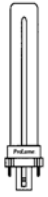

Single Tube
2-Pin



Single Tube
4-Pin



Double Tube
2-Pin/4-Pin

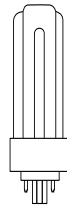

Triple Tube
4-Pin

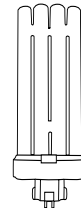

Flat Quad
4-Pin

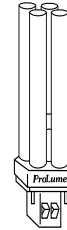

Double
15mm



PLL
4-Pin

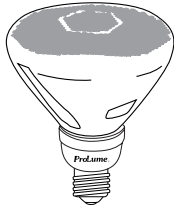

BR38



R20

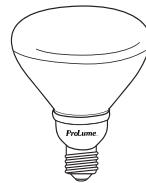

R30/R40



Plug-In R40



A-Shape

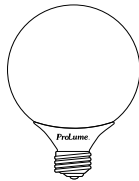

G
Globe

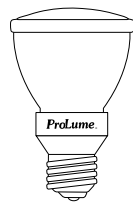

PAR20

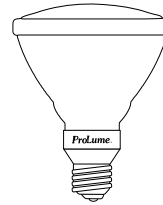

PAR30

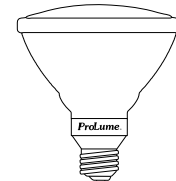

PAR38

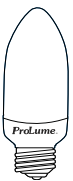

B13
Torpedo



Spiral
GU24



TS EX39



Spiral



T20
Tubular

Base Types

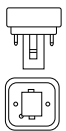

G23



GX23

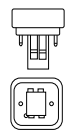

GX23-2



G24q-1



G24q-2

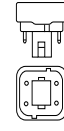

G24q-3



G24d-2

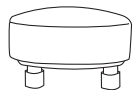

GU24

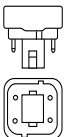

GX24q-3

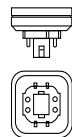

GX24q-4

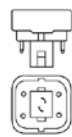

GX24q-5



GX24d-3

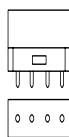

2G11

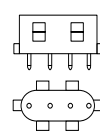

2GX7

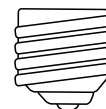

Medium
E26/27

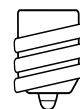

E12



EX39



INCANDESCENT LAMPS Bulb & Base Shapes



A
A-Shape

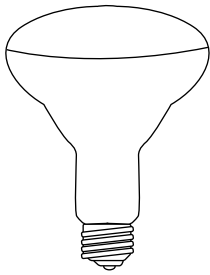

BR
Bulge Neck
Reflector

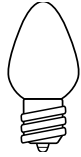

C
Cylindrical



CA8-CA10
Candelabra
Base



B8-B10
Candelabra
Base



CA8-CA10
Edison
Base

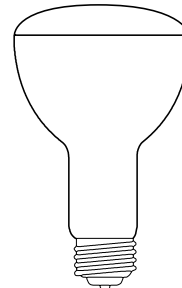

ER
Elliptical
Reflector



B8-B10
Edison
Base



F
Flame



CA5
Candelabra
Base

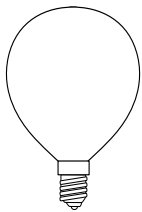

G
Globe
Candelabra

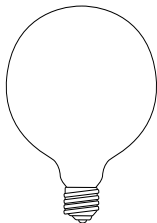

G
Globe
Medium

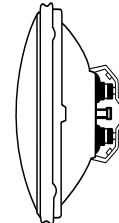

PAR36
Parabolic
Reflector

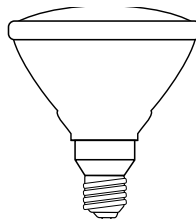

PAR
Parabolic
Reflector



PS
Pear
Straight
Neck

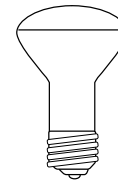

R
Reflector



S
Straight
Side



T
Tubular

Base Types



**Screw
Terminals**

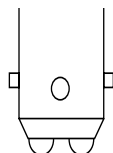

**DC Bayonet
BA15d**



**Candelabra
E12**



E14

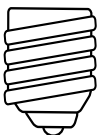

**Intermediate
E17**

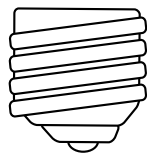

**Medium
E26**

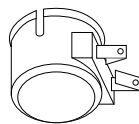

**Medium
Side Prong**

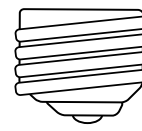

**Mog.
E39**

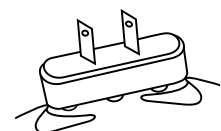

**Mog. End
Prong**



HALOGEN LAMPS
Bulb & Base Shapes

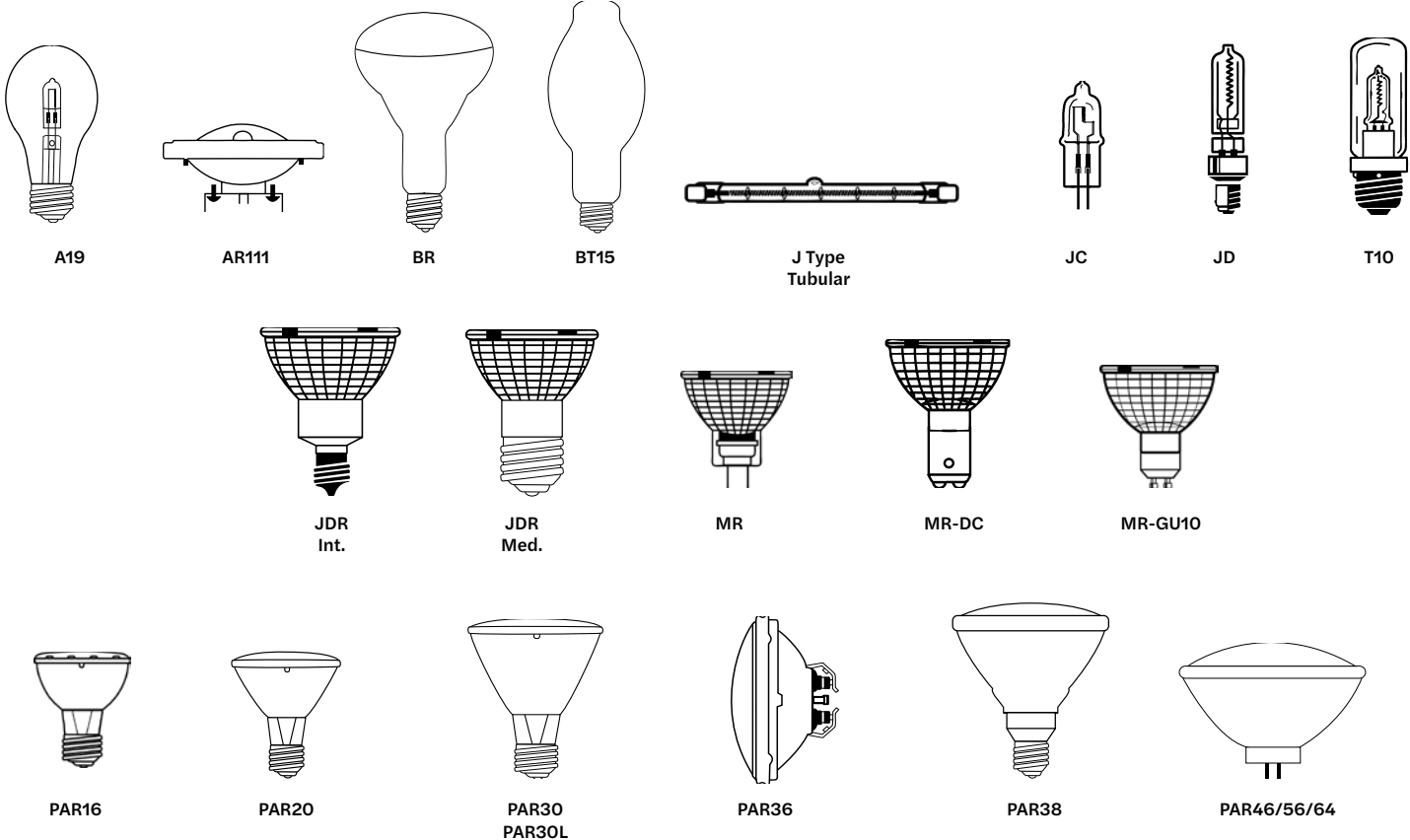

Base Types

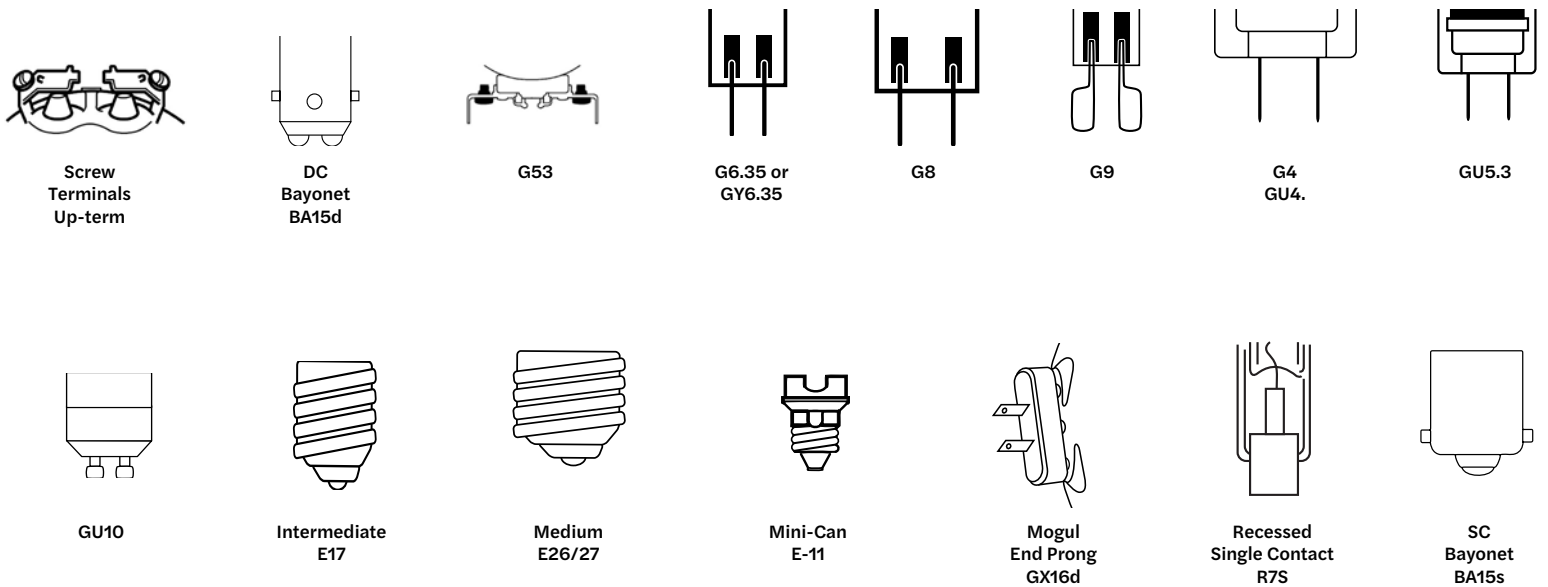



HID LAMPS

Bulb & Base Shapes

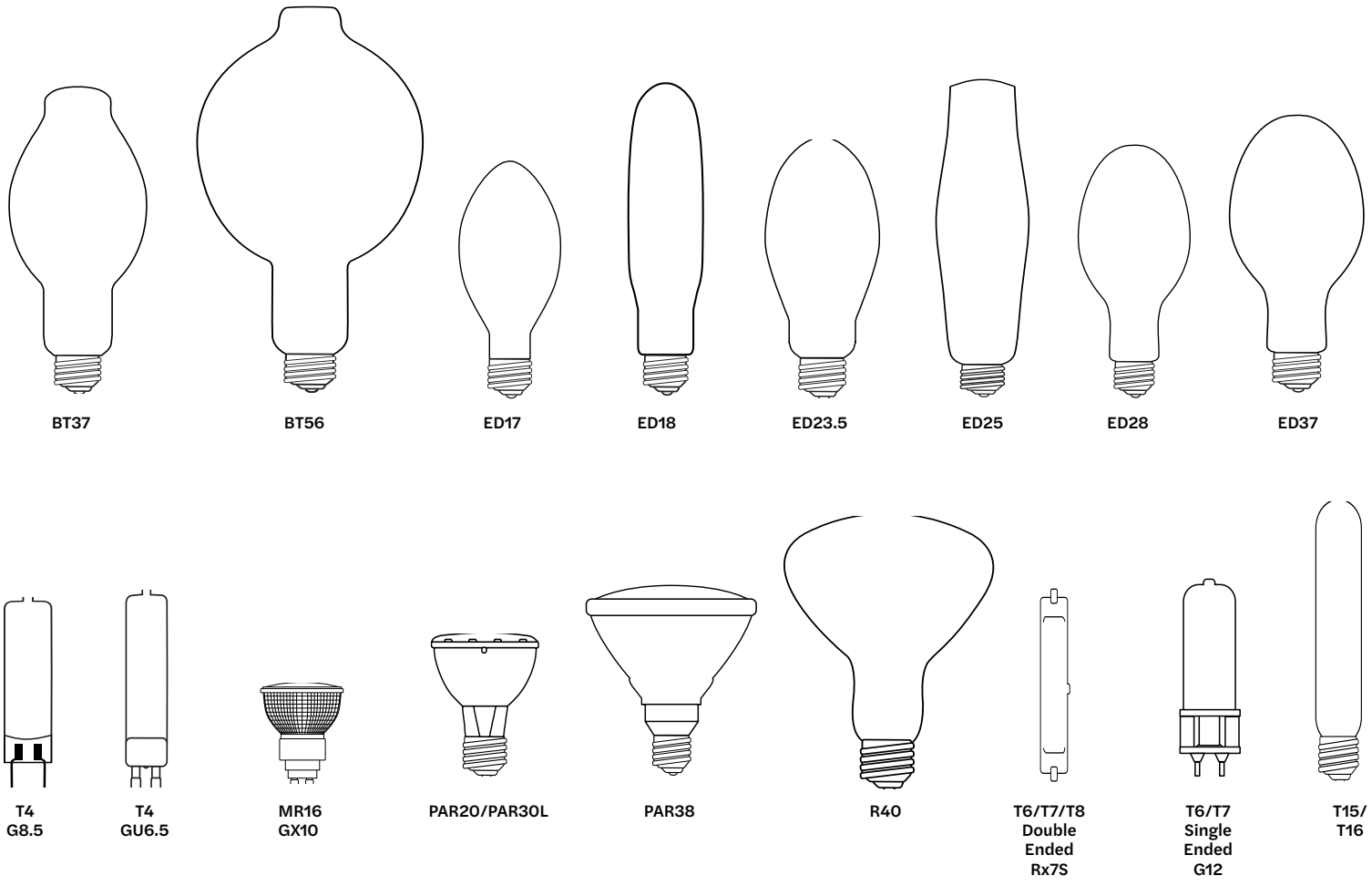

Base Types

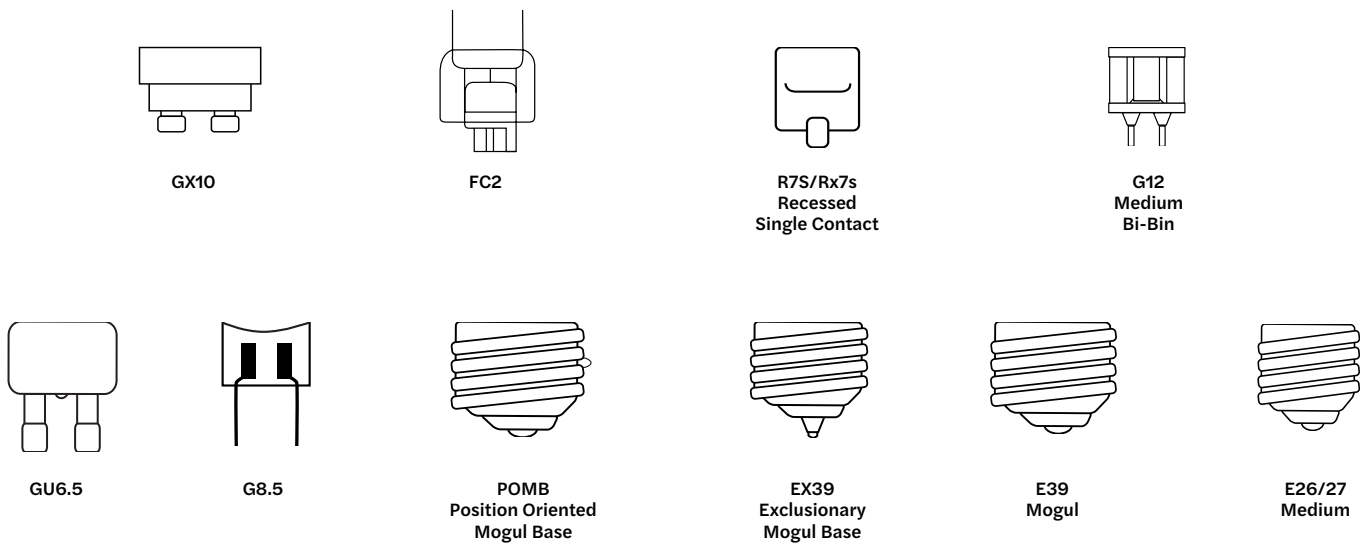



SPECIALTY LAMPS
Bulb & Base Shapes

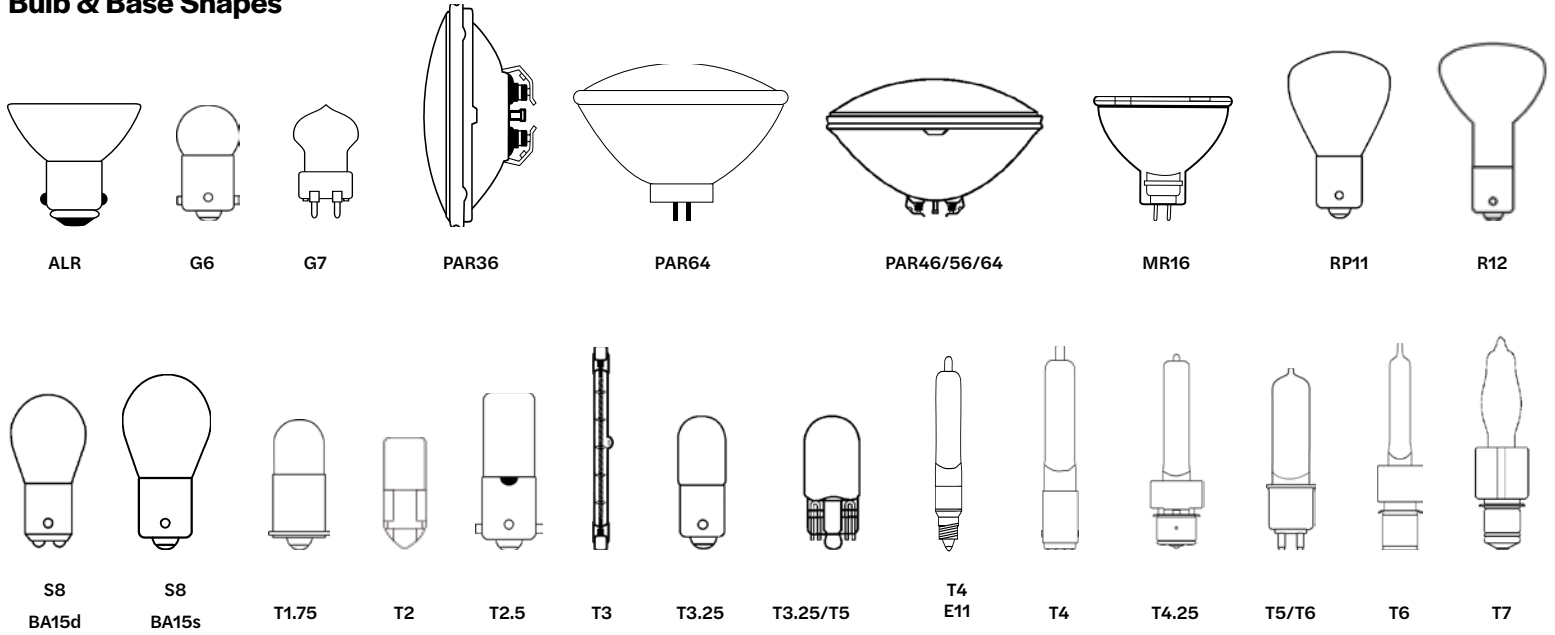

Base Types

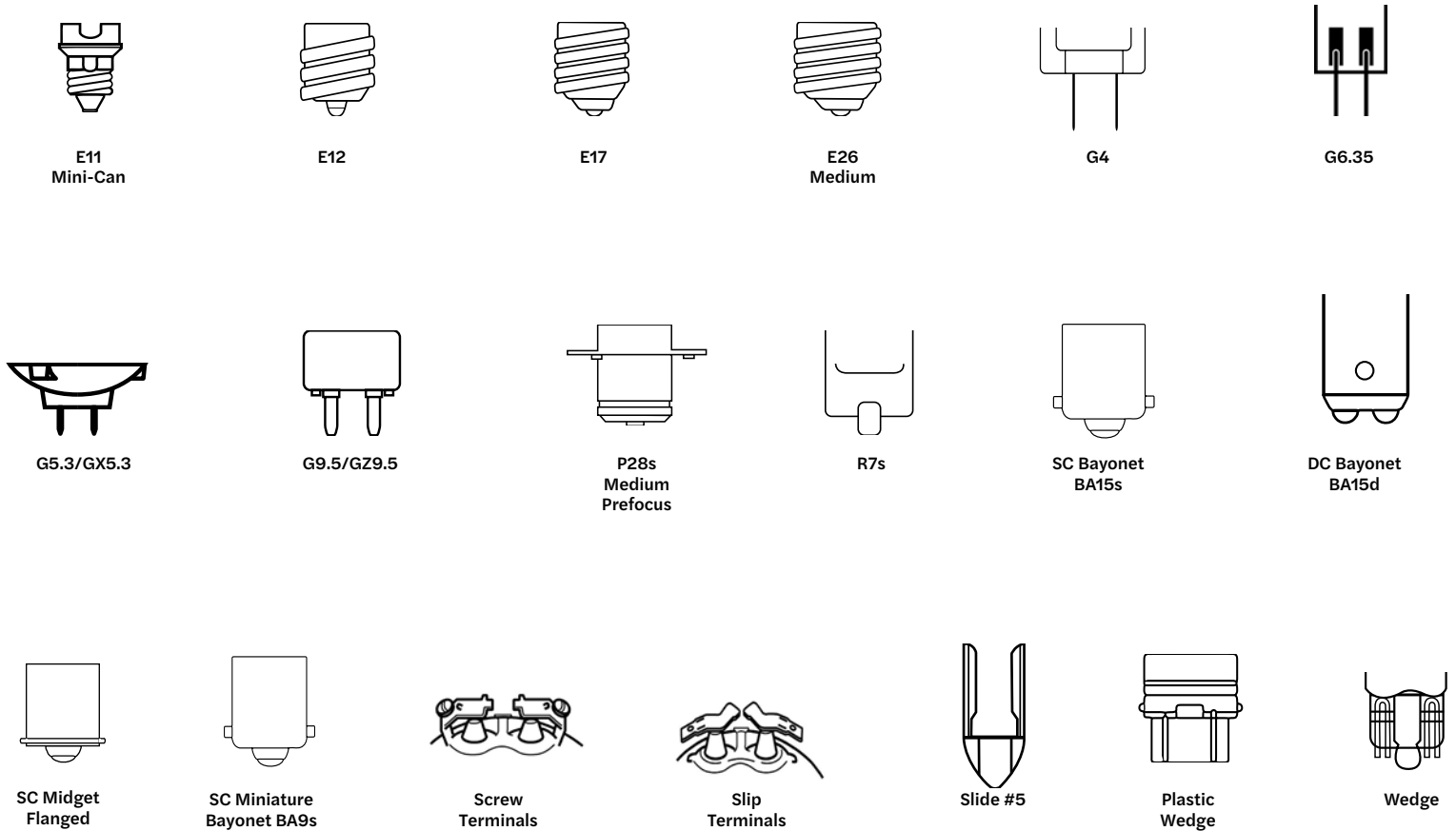



LINEAR FLUORESCENT LAMPS

Bulb & Base Shapes

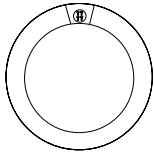

Circleline



T5



T6



T8



T12

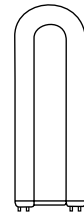

U-Bend

Base Types



Miniature
Bi-Pin

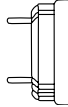

Medium
Bi-Pin

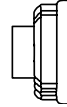

Recessed DC

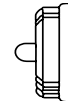

Single Pin

HALCO MERCHANDISE-Contact your Regional Sales Manager or Halco Customer Service for More Details 1-800-677-3334.



Slat Wall Cover



Rolling Rack

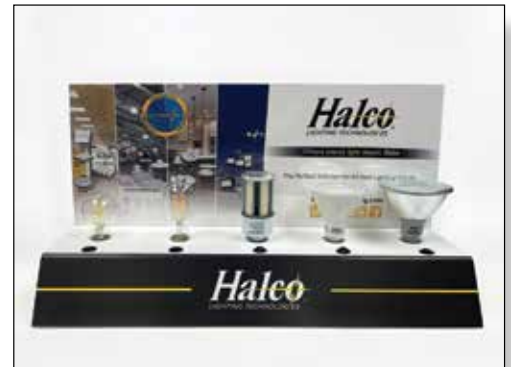

Light Bar



Counter Banner



Counter Stool



Counter Banner



ELECTRONIC FLUORESCENT BALLASTS Cross Reference Guide

Halco SKU	HALCO	ADVANCE	UNIVERSAL/MAGNETEK	HOWARD
	E114RS/120	-	-	-
52200	E120RS/120	-	-	-
50110	E220RS/120	-	-	-
50162	EP2110RS/120	-	B295SR120HP	E2/110RS-120
	EP2110RS/MV	ICN-2S110-SC	B295SRUNVHP	EP2/110RS-MV
52112	EP228PS/MV/MC	ICN-2S28-N	B228PUNV-N	EP2/28T5/PRS/MV
	EP132IS/MV/MC	ICN-1P32-N	B132IUNVHP-N	-
	E232IS/120/R/MC	REB-2P32-SC	B232I120RES-G	E2/32IS-120MC
50176	EP232IS/120/MC	-	B232I120RH-A	EP2/32IS-120MC
	EP232IS/MV/MC	ICN-2P32-N	B232IUNVHP-N	EP2/32IS/MV/MC
50115	EP232IS/H/MV/HE	IOPA-2P32-HL-N	B232IUNVHEH-A	EPH2/32IS/MV/MC/HE
50119	EP232IS/L/MV/HE	IOPA-2P32-LW-N	B232IUNVEL-A	EPL2/32IS/MV/MC/HE
50123	EP232IS/MV/HE	IOPA-2P32-N	B232IUNVHE-A	EP2/32IS/MV/MC/HE
	EP232PS/MV/HE	IOP-2PSP32-SC	B232PUNVHE-B	EP2/PRS/MV/MC/HE
	EP232PS/L/MV/HE	IOP-2PSP32-LW-SC	B232PUNVEL-B	-
50142	EP239HO/PS/MV	ICN-2S39	B239PUNV-D	EP2/39HO/PRS/MV
52118	EP240RS/120	RELB-2S40-N	B240R120HP	E2/40RS-120MC
52118	EP240RS/MV	ICN-2S40-N	-	EP2/40RS/MV/MC
50144	EP254HO/PS/MV	ICN-2S54	B254PUNV-D	EP2/54HO/PRS/MV/90CW
52114	EP254HO/PS/MV/MC	ICN-2S54-N	-	EP2/54HO/PRS/MV/W/MC
50136	EP259IS/MV	IOP-2P59-SC	B259IUNVHP-A	EP2/59IS/MV/MC
	EP260IS/120	-	B260I120M-A	-
	EP260IS/277	-	-	-
52120	EP275IS/MV	ICN-2P60-SC	B260IUNVHP	EP2/75IS/MV/SC
	EP332IS/MV/MC	ICN-3P32-N	B332IUNVHP-A	-
	EP332IS/H/MV/HE	IOPA-3P32-HL-N	B332IUNVHEH-A	-
50168	EP332IS/L/MV/HE	IOPA-3P32-LW-N	B332IUNVEL-A	EPL3/32IS/MV/SC/HE
50170	EP332IS/MV/HE	IOPA-3P32-N	B332IUNVHE-A	EP3/32IS/MV/MC/HE
	E432IS/120/R/SL	REB-4P32-SC	B432I120RES-A	-
	EP432IS/120/SL	-	B432I120RH-A	-
	EP432IS/MV/MC	ICN-4P32-N	B432IUNVHP-A	-
50172	EP432IS/L/MV/HE	IOPA-4P32-LW-N	B432IUNVEL-A	EPL4/32IS/MV/MC/HE
50174	EP432IS/MV/HE	IOPA-4P32-N	B432IUNVHE-A	EP4/32IS/MV/MC/HE
	EP432PS/MV/HE	IOP-4PSP32-SC	B432PUNVHE-A	EP4/32PPRS/MV/SC/HE
	EP432PS/L/MV/HE	IOP-4PSP32LW-SC	B432PUNVEL-A	-
50186	EP454HO/PS/MV	IOP-4PSP54-2LS-G	B454PUNV-E	-
50150	E1CR22RS/120/PT	-	-	-
50148	E2CR72RS/120/PT	-	-	-



ELECTRONIC FLUORESCENT BALLASTS Cross Reference Guide

Electronic CFL Ballast Order Information

HALCO SKU	HALCO PRODUCT CODE	HALCO DESCRIPTION
52102	EP2CF13PS/MV/DC/K	CFL13W 2LAMP ELEC MV PS DC KIT
52104	EP2CF18PS/MV/DC/K	CFL18W 2LAMP ELEC MV PS DC KIT
52108	EP2CF42PS/MV/DC/K	CFL42W 2LAMP ELEC MV PS DC KIT
52108	EP2CF42PS/MV/DC/K	CFL42W 2LAMP ELEC MV PS DC KIT
52108	EP2CF42PS/MV/DC/K	CFL42W 2LAMP ELEC MV PS DC KIT

ELECTRONIC SIGN BALLASTS Cross Reference Guide

HALCO SKU	HALCO	ADVANCE	UNIVERSAL/MAGNETEK	HOWARD
57114	ESB/0216/12	ASB-0412-12-E	ESB216-12	-
57116	ESB/0432/14	ASB-1232-24-E	ESB432-14	-
57120	ESB/0848/46	ASB-2048-46-E	ESB848-46	EBO-6-8-48

Electronic Sign Ballast Order Information

HALCO SKU	HALCO PRODUCT CODE	HALCO DESCRIPTION
57114	ESB/0216/12	Fluorescent 1-2 lamp 216 Multi-voltage T12/HO Instant Start
57120	ESB/0848/46	Fluorescent 4-6 Lamp 8-48 Multi-voltage T12/HO Instant start
57116	ESB/0432/14	Fluorescent 1-4 Lamp 4-32 Multi-voltage T12/HO Instant start

COMPACT FLUORESCENT BALLASTS Cross Reference Guide and Lamp Compatibility Specifications

Halco SKU	HALCO	ADVANCE	UNIVERSAL/MAGNETEK	HOWARD
52102	EP2CF13PS/MV/DC/K	ICF-2S13-H1-LD	C213UNV	EP2/13CF/MV/K
52104	EP2CF18PS/MV/DC/K	ICF-2S18-H1-LD	C218UNV	EP2/18CF/MV/K
52106	EP2CF26PS/MV/DC/K	ICF-2S26-H1-LD	C2642UNV	EP2/26CF/MV/K2
52108	EP2CF42PS/MV/DC/K	ICF-2S42-M2-LD	C242UNV	EP2/42CF/MV/K2



ELECTRONIC HID BALLASTS Cross Reference Guide

HALCO SKU	HALCO PRODUCT CODE	ADVANCE	UNIVERSAL/MAGNETEK	HOWARD
55138	M102/150HX/4T/K	71A5492-001D	M150MLTLC3M500K	M0150-71C-512-K
55192	M110/50HX/4T/K	71A5191-001D	M50MLTLC3M500K	M0050-23C-511-K
55184	M141/1000CWA/4T/K	71A6593-001	P1000MLTAC5M500K	M1000-71C-612-K
55186	M141/1000CWA/5T/K	71A6552-001D	P1000ML5AC5M500K	M1000-81C-611-K
xxxx	M149/750CWA/4T/K	71A64F2-001D	P750MLTAC5M500K	M0750-71C-612-K
55190	M149/750CWA/5T/K	71A6452-001D	P750ML5AC5M500K	M0750-81C-612-K
55150	M131/350CWA/4T/K	71A5993-001D	P350MLTAC4M500K	M0350-71C-6E4-K
55172	M131/350CWA/5T/K	71A5953-001D	P350ML5AC4M500K	-
55148	M132/320CWA/4T/K	71A5892-001D	P320MLTAC4O500K	M0320-71C-6E4-K
55176	M132/320CWA/5T/K	71A5852-001D	P320ML5AC4L500K	-
55162	M135/400CWA/4T/K	71A6092-001D	P400MLTAC4L500K	M0400-71C-6E3-K
55178	M135/400CWA/5T/K	-	P400ML5AC4M500K	-
55160	M138/250CWA/4T/K	71A5792-001D	P250MLTAC4L500K	M0250-71C-611-K
55174	M138/250CWA/5T/K	-	P250ML5AC4M500K	-
xxxx	M150/125CWA/4T/K	-	-	-
55136	M90/100HX/4T/K	71A5390-001D	M100MLTLC3M500K	M0100-71C-512-K
55134	M98/70HX/4T/K	71A5292-001D	M70MLTLC3M500K	M0070-71C-511-K
52118	EP240RS/MV	ICN-2S40-N	-	EP2/40RS/MV/MC

HALCO SKU	HALCO PRODUCT CODE	HALCO DESCRIPTION
55136	M90/100HX/4T/K	100W MH M90 4T PS KIT
55138	M102/150HX/4T/K	150W MH M102 4T PS KIT
55192	NEEDED	NEEDED
55134	M98/70HX/4T/K	70W MH M98 4T PS KIT
55174	M138/250CWA/5T/K	250W MH M138 5T PS KIT
55176	M132/320CWA/5T/K	320W MH M132 5T PS KIT
55178	M135/400CWA/5T/K	400W MH M135 5T PS KIT
55186	M141/1000CWA/5T/K	M141 1000W CWA 5 TAP 120V 208V 240V 277V 1 LAMP CORE COIL BALLAST
55182	M48/1500CWA/5T/K	M48 1500W CWA 5 TAP 120V 208V 240V 277V 480V 1 LAMP CORE COIL BALLAST
55142	M57/175CWA/5T/K	175W MH M57/H39 5T KIT
55146	M58/250CWA/5T/K	250W MH M58/H37 5T KIT
55154	M59/400CWA/5T/K	400W MH M59/H33 5T KIT
55190	M149/750CWA/5T/K	M149 750W CWA 5 TAP 120V 208V 240V 277V 480V MP CORE COIL BALLAST



ELECTROMAGNETIC HID BALLASTS Cross Reference Guide

Halco SKU	HALCO	ADVANCE	UNIVERSAL/MAGNETEK	HOWARD
Pulse Start Metal Halide				
55138	M102/150HX/4T/K	71A5492-001D	M150MLTLC3M500K	M0150-71C-512-K
55192	M110/50HX/4T/K	71A5191-001D	M50MLTLC3M500K	M0050-23C-511-K
55184	M141/1000CWA/4T/K	71A6593-001	P1000MLTAC5M500K	M1000-71C-612-K
55186	M141/1000CWA/5T/K	71A6552-001D	P1000ML5AC5M500K	M1000-81C-611-K
	M149/750CWA/4T/K	71A64F2-001D	P750MLTAC5M500K	M0750-71C-612-K
55190	M149/750CWA/5T/K	71A6452-001D	P750ML5AC5M500K	M0750-81C-612-K
55150	M131/350CWA/4T/K	71A5993-001D	P350MLTAC4M500K	M0350-71C-6E4-K
55172	M131/350CWA/5T/K	71A5953-001D	P350ML5AC4M500K	-
55148	M132/320CWA/4T/K	71A5892-001D	P320MLTAC4O500K	M0320-71C-6E4-K
55176	M132/320CWA/5T/K	71A5852-001D	P320ML5AC4L500K	-
55162	M135/400CWA/4T/K	71A6092-001D	P400MLTAC4L500K	M0400-71C-6E3-K
55178	M135/400CWA/5T/K	-	P400ML5AC4M500K	-
55160	M138/250CWA/4T/K	71A5792-001D	P250MLTAC4L500K	M0250-71C-611-K
55174	M138/250CWA/5T/K	-	P250ML5AC4M500K	-
	M150/125CWA/4T/K	-	-	-
55136	M90/100HX/4T/K	71A5390-001D	M100MLTLC3M500K	M0100-71C-512-K
55134	M98/70HX/4T/K	71A5292-001D	M70MLTLC3M500K	M0070-71C-511-K
Standard Metal Halide				
	M48/1500CWA/4T/K	71A6772-001D	M1500MLTAC5M500K	M1500-71C-214-K
55182	M48/1500CWA/5T/K	-	-	-
5156	M47/1000CWA/4T/K	71A6572-001	M1000MLTAC5M500K	M1000-71C-214-K
55158	M47/1000CWA/5T/K	71A6552-001	M1000ML5AC5M500K	M1000-81C-213-K
55140	M57/175CWA/4T/K	71A5570-001D	M175MLTAC3M500K	M0175-71C-214-K
55142	M57/175CWA/5T/K	-	M175ML5AC3M500K	M0175-81C-214-K
55144	M58/250CWA/4T/K	71A5771-001D	M250MLTAC3M500K	M0250-71C-215-K
55146	M58/250CWA/5T/K	71A5750-001D	M250ML5AC3M500K	M0250-81C-215-K
55152	M59/400CWA/4T/K	71A6071-001D	M400MLTAC4M500K	M0400-71C-213-K
55154	M59/400CWA/5T/K	71A6051-001D	M400ML5AC4M500K	M0400-81C-212-K

Ignitor Guide

Halco SKU	Product Code	Ballast	Diam. (mm)	Diam. (in)	Height (mm)	Height (in)
55901	IGN/HPS1	35W - 150W HPS				
55903	IGN/HPS2	200W - 400W HPS				



PULSE START MH BALLASTS Cross Reference & Ignitor Guide

HALCO SKU	HALCO PRODUCT CODE	ADVANCE	UNIVERSAL/MAGNETEK	HOWARD
High Pressure Sodium				
55120	S50/250CWA/4T/K	71A8271-001D	S250MLTAC4M500K	S0250-71C-214-K
55122	S50/250CWA/5T/K	71A8251-001D	S250ML5AC4M500K	S0250-81C-212-K
55124	S51/400CWA/4T/K	71A8473-001D	S400MLTAC5M500K	S0400-71C-212-K
55126	S51/400CWA/5T/K	71A8453-001D	S400ML5AC5M500K	S0400-81C-212-K
55128	S52/1000CWA/4T/K	71A8773-001	S1000MLTAC5M500K	S1000-71C-212-K
55130	S52/1000CWA/5T/K	71A8753-001	S1000ML5AC5M500K	S1000-81C-212-K
55112	S54/100HX/4T/K	71A8071-001D	S100MLTLC3M500K	S0100-71C-512-K
	S54/100R/120/K	71A8007-001DB	-	S0100-02C-111-K
55116	S55/150HX/4T/K	71A8172-001D	S150MLTLC3M500K	S0150-71C-512-K
55114	S55/150R/120/K	71A8107-001DB	-	S0150-02C-111-K
55108	S62/70HX/4T/K	71A7971-001D	S70MLTLC3M500K	S0070-71C-512-K
55106	S62/70R/120/K	71A7907-001DB	-	S0070-02C-111-K
55118	S66/200CWA/4T/K	71A8970-001D	S200MLTAC4M500K	S0200-71U-211-K
55104	S68/50R/120/K	71A7807-001DB	-	S0050-02C-111-K
55102	S76/35R/120/K	71A7707-001DB	-	S0035-02C-111-K

Ignitor Guide

Halco SKU	HALCO PRODUCT CODE	Ballast	Diam. (mm)	Diam. (in)	Height (mm)	Height (in)
55901	IGN/HPS1	35W - 150W HPS				
55903	IGN/HPS2	200W - 400W HPS				



Cross Reference Guide

HPS Ballast Ordering Information

HALCO SKU	HALCO PRODUCT CODE	HALCO DESCRIPTION
55130	S52/1000CWA/5T/K	1000W LU S52 5T KIT
55112	S54/100HX/4T/K	100W LU S54 4T KIT
55116	S55/150HX/4T/K	150W LU S55 4T KIT
55120	S50/250CWA/4T/K	250W LU S50 4T KIT
55126	S51/400CWA/5T/K	400W LU S51 5T KIT
55124	S51/400CWA/4T/K	400W LU S51 4T KIT
55104	S68/50R/120/K	50W LU S68 120V KIT
55108	S62/70HX/4T/K	70W LU S62 4T KIT

PS MH Ballast Ordering Information

HALCO SKU	HALCO PRODUCT CODE	HALCO DESCRIPTION
55136	M90/100HX/4T/K	100W MH M90 4T PS KIT
55138	M102/150HX/4T/K	150W MH M102 4T PS KIT
55192	M110/50HX/4T/K	50W MH M110 4T PS KIT
55134	M98/70HX/4T/K	70W MH M98 4T PS KIT
55174	M138/250CWA/5T/K	250W MH M138 5T PS KIT
55176	M132/320CWA/5T/K	320W MH M132 5T PS KIT
55178	M135/400CWA/5T/K	400W MH M135 5T PS KIT

Standard MH Ballast Ordering Information

HALCO SKU	HALCO PRODUCT CODE	HALCO DESCRIPTION
55186	M141/1000CWA/5T/K	M141 1000W CWA 5 TAP 120V 208V 240V 277V 1 LAMP CORE COIL BALLAST
55182	M48/1500CWA/5T/K	M48 1500W CWA 5 TAP 120V 208V 240V 277V 480V 1 LAMP CORE COIL BALLAST
55142	M57/175CWA/5T/K	175W MH M57/H39 5T KIT
55146	M58/250CWA/5T/K	250W MH M58/H37 5T KIT
55154	M59/400CWA/5T/K	400W MH M59/H33 5T KIT
55190	M149/750CWA/5T/K	M149 750W CWA 5 TAP 120V 208V 240V 277V 480V MP CORE COIL BALLAST

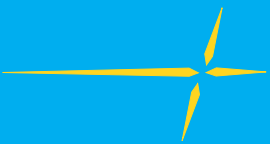

Cross Reference Guide

T12 Ballast Ordering Information

HALCO SKU	HALCO PRODUCT CODE	HALCO DESCRIPTION
52118	EP240RS/MV/MC	F40T12 2 LAMP ELEC MV RS
52120	EP275IS/MV/SL	F96T12 2 LAMP ELEC MV IS
50164	EP2110RS/MV	F96 T12 HO 2 LAMP ELEC MV RS

T5 Ballast Ordering Information

HALCO SKU	HALCO PRODUCT CODE	HALCO DESCRIPTION
52112	EP228PS/MV/MC	F28T5 2LAMP ELEC MV PS
50144	EP254HO/PS/MV	F54 T5 HO 2 LAMP ELEC MV PS
50186	EP454HO/PS/MV	F54 T5 HO 4 LAMP ELEC MV PS

T8 Ballast Ordering Information

HALCO SKU	HALCO PRODUCT CODE	HALCO DESCRIPTION
50123	EP232IS/MV/HE	F32T8 2LAMP ELEC MV IS HIGH PERF
50123	EP232IS/MV/HE	F32T8 2LAMP ELEC MV IS HIGH PERF
50180	EP232PS/MV/HE	F32T8 2 LAMP PROGRAMMED START HIGH PERFORMANCE NORMAL BALLAST FACTOR NON-DIMMABLE
50170	EP332IS/MV/HE	F32T8 3LAMP ELEC MV IS HIGH PERF
50174	EP432IS/MV/HE	F32T8 4LAMP ELEC MV IS HIGH PERF

ELECTROMAGNETIC HID BALLASTS Capacitor Guide

Halco SKU	Product Code	Halco Ballast Code	Mfd	Volts	Diam. (mm)	Diam. (in)	Height (mm)	Height (in)
DRY FILM								
55859	CAP/MH175	M57/175CWA/4T/K M57/175CWA/5T/K	10	400	35	1.38	78	3.08
55868	CAP/MH400/DRY	M59/400/CWA/4T/K	24	400	45	1.77	93	3.66
OIL-FILLED								
55869	CAP/MH1000	M47/1000CWA/4T/K M47/1000CWA/5T/K	24	480	50	1.97	103	4.06

* Product will be discontinued when inventory is depleted



Here is a sampling of just some of the ballasts we offer at Halco. To see the full listing, please visit www.halcolighting.com.

BALLASTS

PRODUCT SKU	Description	Commodity
50174	EP432IS/MV/HE 50174 F32T8 4LAMP ELEC MV IS HIGH PERF	T8 Ballasts
50123	EP232IS/MV/HE 50123 F32T8 2LAMP ELEC MV IS HIGH PERF	T8 Ballasts
55158	M47/100CWA/5T/K 55158 1000W MH M47/H36 5T KIT	Standard MH Ballast
55154	M59/400CWA/5T/K 55154 400W MH M59/H33 5T KIT	Standard MH Ballast
55182	M48/1500CWA/5T/K 55182 M48 1500W CWA 5 TAP 120V 208V 240V 277V 480V 1 LAMP CORE COIL BALLAST	Standard MH Ballast
50170	EP332IS/MV/HE 50170 F32T8 3LAMP ELEC MV IS HIGH PERF	T8 Ballasts
52106	EP2CF26PS/MV/DC/K 52106 CFL26W 2LAMP ELEC MV PS DC KIT	Elec CFL Ballast
50144	EP254HO/PS/MV 50144 F54 T5 HO 2 LAMP ELEC MV PS	T5 Ballasts
50186	EP454HO/PS/MV 50186 F54 T5 HO 4 LAMP ELEC MV PS	T5 Ballasts
52108	EP2CF42PS/MV/DC/K 52108 CFL42W 2LAMP ELEC MV PS DC KIT	Elec CFL Ballast
57116	ESB/0432/14 57116 ELEC SIGN BLST 1-4 LAMP 4-32 MV	Specialty Ballasts
55126	S51/400CWA/5T/K 55126 400W LU S51 5T KIT	HPS Ballast
52118	EP240RS/MV/MC 52118 F40T12 2 LAMP ELEC MV RS	T12 Ballasts
52112	EP228PS/MV/MC 52112 F28T5 2LAMP ELEC MV PS	T5 Ballasts
52120	EP275IS/MV/SL 52120 F96T12 2 LAMP ELEC MV IS	T12 Ballasts
55112	S54/100HX/4T/K 55112 100W LU S54 4T KIT	HPS Ballast
55130	S52/1000CWA/5T/K 55130 1000W LU S52 5T KIT	HPS Ballast
55146	M58/250CWA/5T/K 55146 250W MH M58/H37 5T KIT	Standard MH Ballast
55116	S55/150HX/4T/K 55116 150W LU S55 4T KIT	HPS Ballast
55152	M59/400CWA/4T/K 55152 55168 400W MH M59/H33 4T KIT	Standard MH Ballast



Scan to view Halco Lighting website

Sign Up for MyHalco Today



Scan to view the Digital Guide

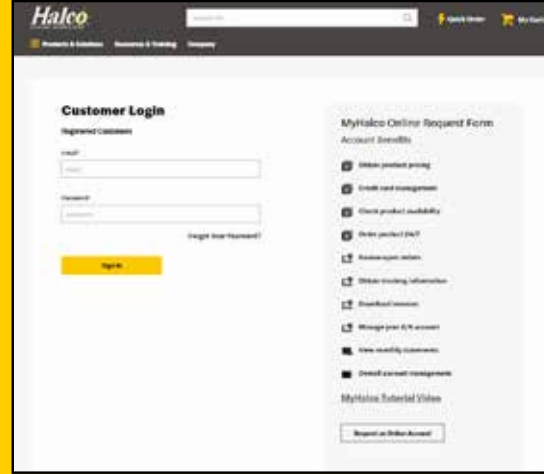

MyHalco is an online portal that lets you access your account 24/7...

- Obtain Product Pricing
- Check Product Availability
- Place Orders and Review Open Orders
- Track Shipments
- Download Invoices and Monthly Statements

Best of all – you can download your price list any time you want!

Signing up is easy. Scan the code at the top left corner to be directed to halcolighting.com. Look for MyHalco at the top of the home page. Complete a short online application and within 24 hours you will receive a password to begin using MyHalco.

Don't delay – sign up at halcolighting.com!



Atlanta
2940 Pacific Drive
Norcross, GA 30071

Chicago
845 Lively Blvd
Wood Dale, IL 60191

Cleveland
3501 Croton Avenue
Cleveland, OH 44115

800.677.3334
FAX: 800.880.0822
www.halcolighting.com

Houston
6323 Brookhill Drive
Houston, TX 77087

Phoenix
3103 E. Broadway, Ste 100
Phoenix, AZ 85040